



Velocity Keypad

AT-VKP-8E

Atlona Manuals
Control

Version Information

Version	Release Date	Notes
1	Jan 2024	Release

Sales, Marketing, and Customer Support

Main Office

Atlona Incorporated
70 Daggett Drive
San Jose, CA 95134
United States

Office: +1.408.962.0515 (US/International)

Sales and Customer Service Hours
Monday - Friday: 6:00 a.m. - 3:30 p.m. (PST)

<https://atlona.com/>

International Headquarters

Atlona International AG
Tödistrasse 18
8002 Zürich
Switzerland
Office: +41 43 508 4321

Sales and Customer Service Hours
Monday - Friday: 09:00 - 17:00 (UTC +1)

Operating Notes



IMPORTANT: Visit <https://atlona.com/product/at-vkp-8e> for the latest firmware updates and User Manual.

Warranty



To view the product warranty, use the following link or QR code:

<https://atlona.com/warranty/>.

Important Safety Information

CAUTION
 RISK OF ELECTRIC SHOCK
 DO NOT OPEN

CAUTION: TO REDUCE THE RISK OF ELECTRIC SHOCK DO NOT OPEN ENCLOSURE OR EXPOSE TO RAIN OR MOISTURE. NO USER-SERVICEABLE PARTS INSIDE REFER SERVICING TO QUALIFIED SERVICE PERSONNEL.



The exclamation point within an equilateral triangle is intended to alert the user to the presence of important operating and maintenance instructions in the literature accompanying the product.



The information bubble is intended to alert the user to helpful or optional operational instructions in the literature accompanying the product.

- 1 Read these instructions.
- 2 Keep these instructions.
- 3 Heed all warnings.
- 4 Follow all instructions.
- 5 Do not use this product near water.
- 6 Clean only with a dry cloth.
- 7 Do not block any ventilation openings. Install in accordance with the manufacturer's instructions.
- 8 Do not install or place this product near any heat sources such as radiators, heat registers, stoves, or other apparatus (including amplifiers) that produce heat.
- 9 Do not defeat the safety purpose of a polarized or grounding-type plug. A polarized plug has two blades with one wider than the other. A grounding type plug has two blades and a third grounding prong. The wide blade or the third prong are provided for your safety. If the provided plug does not fit into your outlet, consult an electrician for replacement of the obsolete outlet.
- 10 Protect the power cord from being walked on or pinched particularly at plugs, convenience receptacles, and the point where they exit from the product.
- 11 Only use attachments/accessories specified by Atlona.
- 12 To reduce the risk of electric shock and/or damage to this product, never handle or touch this unit or power cord if your hands are wet or damp. Do not expose this product to rain or moisture.
- 13 Unplug this product during lightning storms or when unused for long periods of time.
- 14 Refer all servicing to qualified service personnel. Servicing is required when the product has been damaged in any way, such as power-supply cord or plug is damaged, liquid has been spilled or objects have fallen into the product, the product has been exposed to rain or moisture, does not operate normally, or has been dropped.



FCC Compliance

FCC Compliance and Advisory Statement: This hardware device complies with Part 15 of the FCC rules. Operation is subject to the following two conditions: 1) this device may not cause harmful interference, and 2) this device must accept any interference received including interference that may cause undesired operation. This equipment has been tested and found to comply with the limits for a Class A digital device, pursuant to Part 15 of the FCC Rules. These limits are designed to provide reasonable protection against harmful interference in a commercial installation. This equipment generates, uses, and can radiate radio frequency energy and, if not installed or used in accordance with the instructions, may cause harmful interference to radio communications. However there is no guarantee that interference will not occur in a particular installation. If this equipment does cause harmful interference to radio or television reception, which can be determined by turning the equipment off and on, the user is encouraged to try to correct the interference by one or more of the following measures: 1) reorient or relocate the receiving antenna; 2) increase the separation between the equipment and the receiver; 3) connect the equipment to an outlet on a circuit different from that to which the receiver is connected; 4) consult the dealer or an experienced radio/TV technician for help. Any changes or modifications not expressly approved by the party responsible for compliance could void the user's authority to operate the equipment. Where shielded interface cables have been provided with the product or specified additional components or accessories elsewhere defined to be used with the installation of the product, they must be used in order to ensure compliance with FCC regulations.

Copyright, Trademark, and Registration

© 2024 Atlona Inc. All rights reserved. "Atlona" and the Atlona logo are registered trademarks of Atlona Inc. Pricing, specifications and availability subject to change without notice. Actual products, product images, and online product images may vary from images shown here.

All other trademark(s), copyright(s), and registered technologies mentioned in this document are the properties of their respective owner(s).

Table of Contents

Introduction	6
Features	6
Package Contents	6
Panel Description	7
Installation	8
Captive Screw Connector	8
Mounting Instructions	8
Connection Diagram	10
Initial VKP Setup	11
Local Mode	14
Upload / Download Config	14
Upload Firmware	15
Change Network	16
API Mode	17
Open Cloud	17
Certificates	18
Rebuild Certificate	18
Save Certificate	18
Control Configuration	19
IoT Mode Template Selection	19
Virtual Template Selection	21
Assets	23
Add New	23
Add Sub Folder	24
Edit Folder	24
Move Folder/Asset	24
View Allowed Users	24
Invite Users	25
Delete Folder/Asset	25
Settings	26
System	26
Snapshots	27
Networking	27
Logs	28
Access	28
Devices	29
Variables	30
Macros	31
VKP-8E Macro Commands	31
Configure	33
Appendix	37
Specifications	37

Introduction

The Atlona AT-VKP-8E is a simple yet powerful 8 button IP-based control system in a wallplate form factor. The buttons are fully configurable for controls such as display power, input switching, audio levels, or any other functions supported by system devices. In addition to Ethernet, the VKP-8E also features RS-232 for control of legacy devices. For enhanced customization, the VKP-8E incorporates a 2.7" e-ink display that supports multiple pages to dynamically change icons and text associated with the buttons. LED indicators for each button and a multi-step LED level indicator provide additional feedback to users. The VKP-8E is designed to mount in one-gang US junction boxes and comes with both black and white faceplates that attach to the button panel via magnets. Power over Ethernet (PoE) provides both power and data to the panel over a single cable. For setup, the VKP-8E uses a revolutionary new configuration platform called Atlona Cloud. It provides an intuitive interface for mapping control commands, text, and icons to buttons using the extensive library of Atlona and third-party device drivers. When configuration is complete, lightweight instructions can either be sent to the VKP-8E directly over the network or stored in a file for later upload.

Features

- Simple yet powerful keypad control system for one room of up to 10 devices
- 8 buttons for controlling display power, source input, volume levels, and other system functions
- RGB LED indicators for each button and a multi-step LED level indicator provide user feedback
- 2.7" high contrast e-paper display with 264 x 172 resolution allows custom icons and text to be associated with each button and dynamically change with different pages
- IP-based for controlling system devices over the network
- Bi-directional RS-232 port for controlling projectors, switchers, and other legacy devices
- Configure with Atlona Cloud for standalone systems, or use as a supplemental user interface in Velocity systems
- Pre-configured control files available for our most popular switchers
- Power over Ethernet (PoE) for remote power and network connection with a single cable
- One-gang enclosure for US wallplate openings – black and white faceplates included

Package Contents

- 1 x AT-VKP-8E
- 1 x White faceplate
- 1 x 3-pin Captive Screw Connector
- 4 x Mounting screws
- 2 x Face plate screws
- 1 x Installation Guide

Panel Description

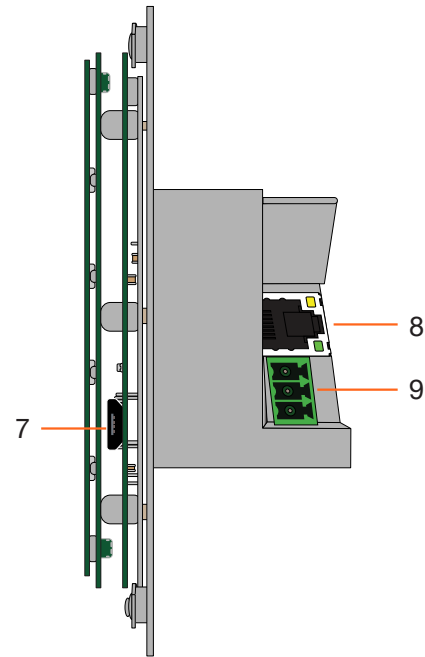
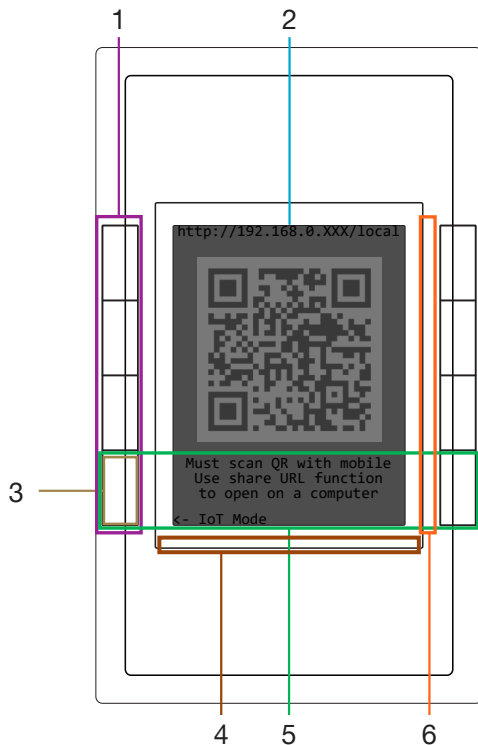

1 Control Buttons

Once set up, use the buttons to trigger the control commands.

2 E-ink Display

Displays the connection and start up information, along with button icons and text as set inside cloud configuration

3 Mode Button

During set up, use the bottom left button to switch between Internet of Things (IoT) and Local mode.

4 Volume LEDs

LED indicators that display volume level feedback.

5 Settings Buttons

Press and hold the bottom two buttons to switch to additional settings options for the VKP.

6 Button LEDs

These can be set to display multiple colors within the settings to provide status.

7 Service Port

This port is used by Technical Support and is not for users.

8 LAN

Connect an Ethernet cable to this port for power and control/configuration.

9 RS-232 Port

Connect the included 3-pin captive screw connector to this port then to the control device.

Installation

Captive Screw Connector

RS-232

A 3-pin captive screw connector has been included for RS-232.

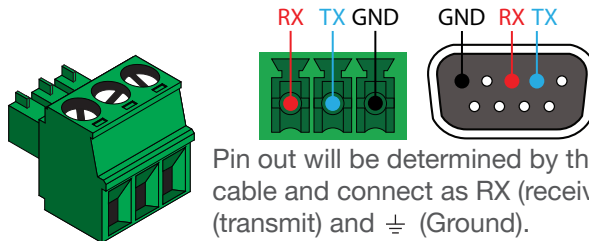

Pin out will be determined by the RS-232 cable and connect as RX (receive), TX (transmit) and \perp (Ground).

Mounting Instructions

The AT-VKP-8E can be mounted to a 1-gang back box.

- 1 Select the type of 1-gang back box to use and install into a wall.

i NOTE: Install using the region's safety guidelines for electrical boxes.

- 2 Thread the Ethernet cable through the 1-gang box.
- 3 *Optional* Run the RS-232 connector and cable through the wall and back box.

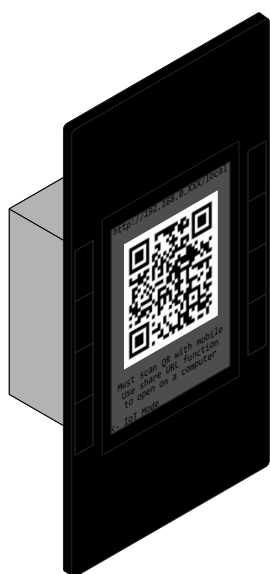

- 4 Remove the faceplate from the front of the VKP-8E. The faceplate is attached using magnets, so simply grab the faceplate from the sides and pull it off the unit.
- 5 Remove the four screws from the top and bottom of the unit (circled to the right) and pull the mounting plate from the unit (shown below).

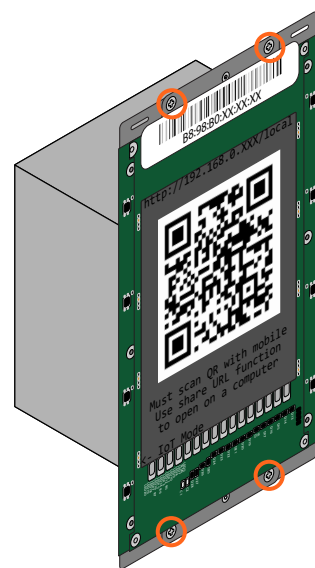
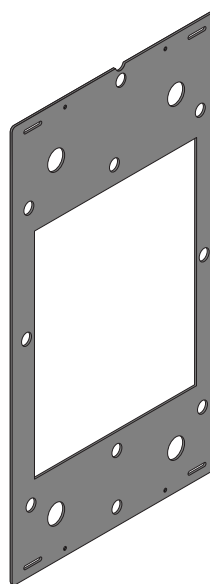
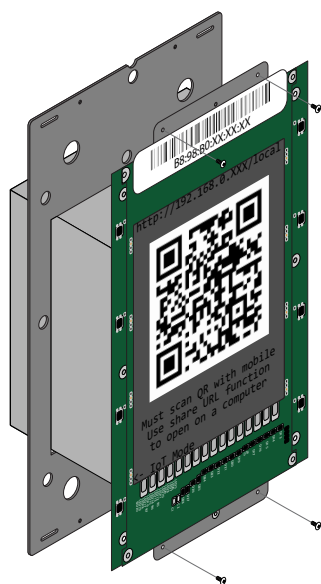

- 6 Thread the Ethernet cable through the mounting plate.
- 7 Install the mounting plate into the wall, using two of the included mounting screws (4 screws are included, 2 each of different sizes for varied US back boxes).
- 8 Connect the Ethernet cable (and/or *optional* RS-232 connector) to the LAN port (and RS-232 port) on the back of the unit.

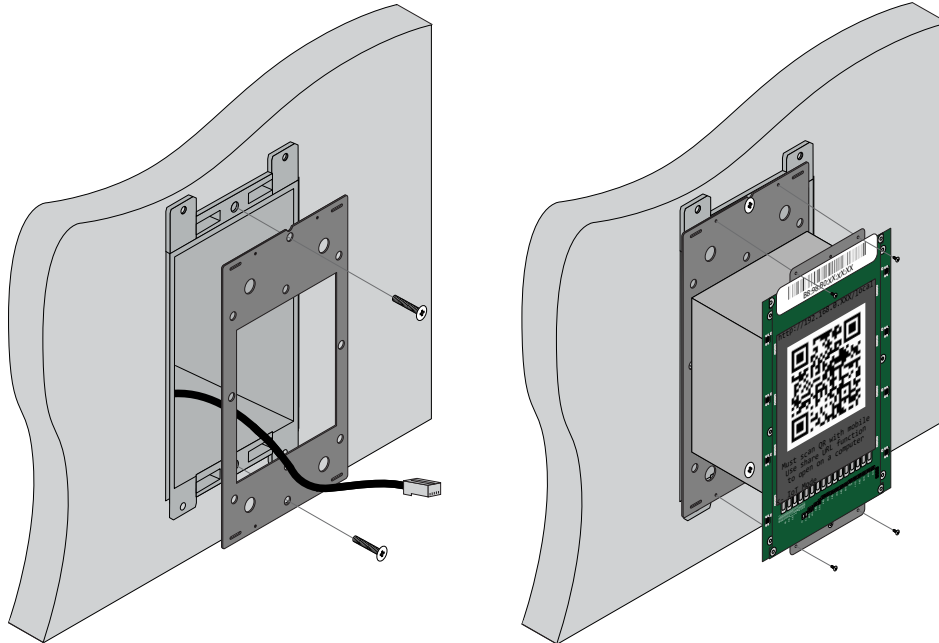

- 9 Install the unit into the back box, securing it using the 4 screws removed earlier through the 4 holes in the unit and mounting plate.
- 10 Once secured to the wall, place the front face plate back onto the unit. The magnets will secure it in place.
- 11 *Optional* To ensure the face plate stays in place, use the included face plate screw and thread it through the bottom of the face plate (an extra screw is included in case one is lost).

The unit is fully installed.

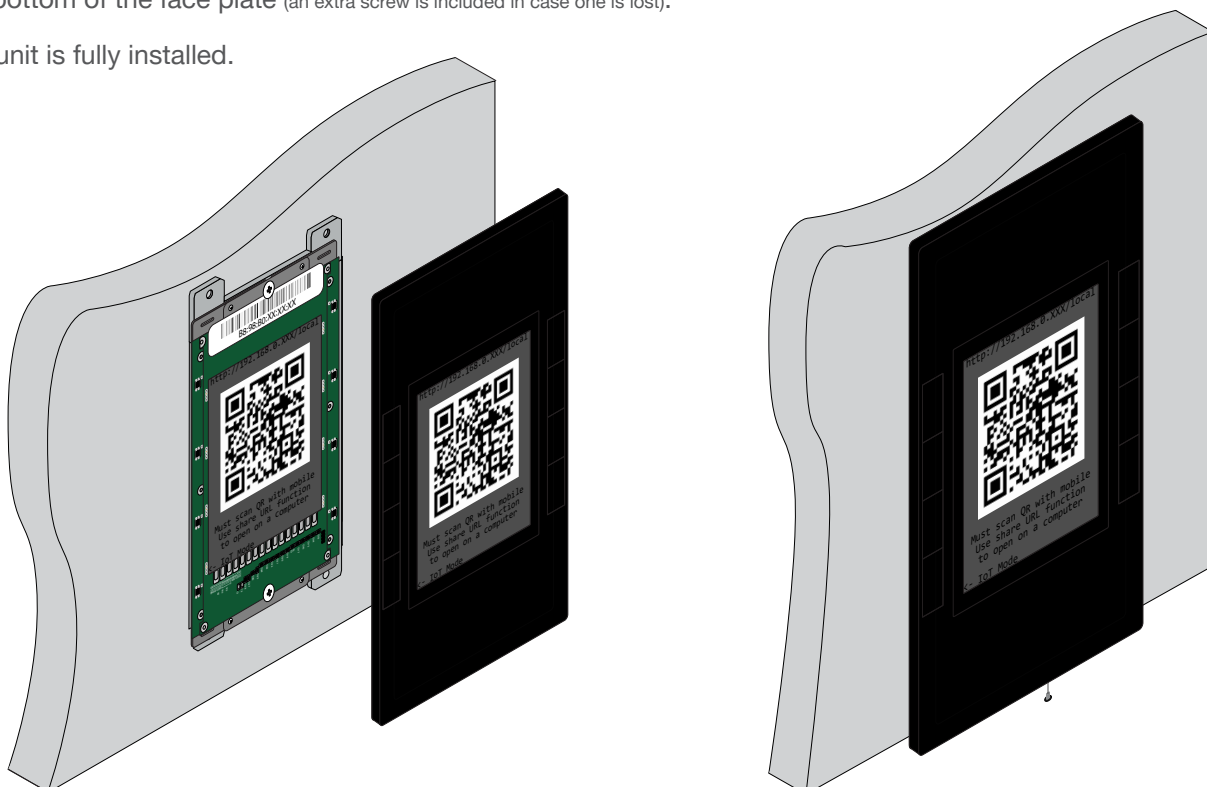

Connection Diagram

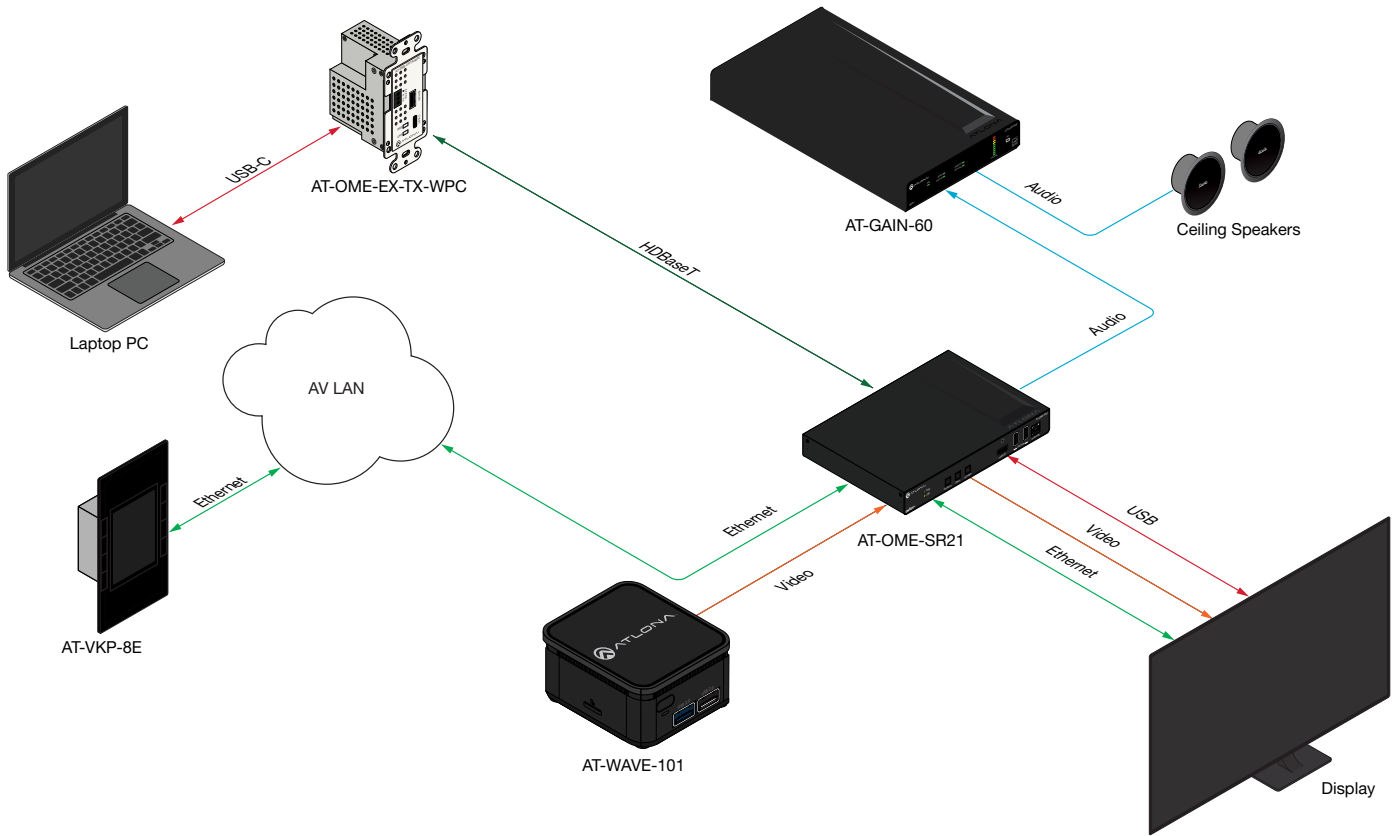

Initial VKP Setup

The AT-VKP-8E has two modes for set up: Local and IoT (Internet of Things - recommended). No matter which mode is set on the AT-VKP-8E, the computer doing the configuration must be connected to the Internet.

NOTE: If the local network is not recognizing or speaking to the unit, ensure that port 443 (https) is enabled. If port 443 is disabled, the unit may not speak correctly across the network.

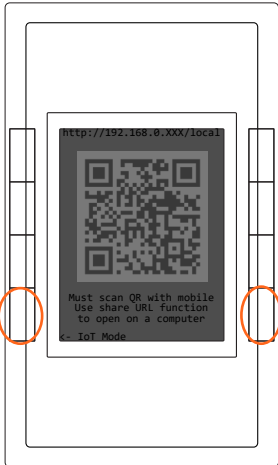

For easy network configuration, press and hold the bottom left & right buttons for 2 seconds. Once released, it will open an advanced options screen.

From here, the unit can be changed from DHCP to Static IP modes by pressing the corresponding buttons to the mode. It may take 5-10 seconds to switch IPs, the IP will display at the top. Static IP will set the unit to 192.168.0.231.

The unit can be switched between Local and IoT Mode using the bottom buttons, this will take the unit out of advanced mode.

The unit can be factory reset (does not unregister the unit) and reboot from advanced mode if needed.

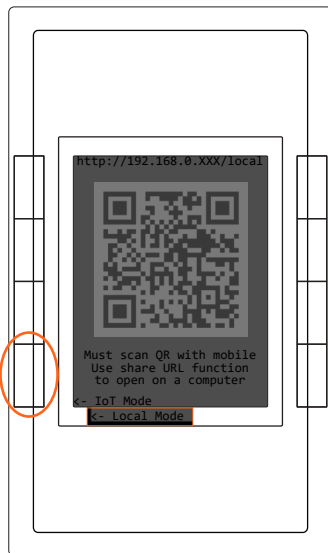

Modes can also be switched by pressing the bottom left hand button from the main screen.

Local Mode

Local mode will make the local webUI available to do some basic unit configuration. Scan the QR code or type in the ip address located at the top of the unit (ex 192.168.0.xxx/local) to access the webUI of the unit. This will allow for uploading and downloading configuration files to the unit, firmware updating, changing network settings, and more.

While local mode allows for basic unit configuration, control configuration will still need to be done online, with the config file being uploaded manually to the unit in the webUI, rather than synced through the cloud.

IoT Mode

IoT mode sets the unit to be updated through the cloud configurator whenever a change is made or a firmware update is received.

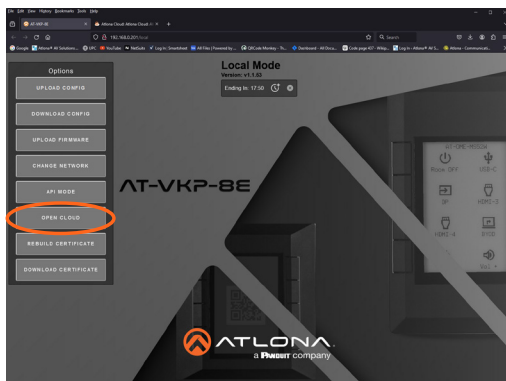

Both modes will have control configured through <https://cloud.atlona.com>. To get to the configuration, scan the QR code (when in IoT Mode) on a phone, tablet, etc, type the IP address of the unit listed at the top of the e-ink display (minus /local in Local Mode), click the Open Cloud button when in the local webUI (in local mode), or simply enter <https://cloud.atlona.com> into a browser. All options will lead to <https://cloud.atlona.com>.

NOTE: The IP address will only redirect if the unit and the PC for configuration are connected to the same network.

Login for Configuration

Once cloud.atlona.com page has been opened. It may take a few seconds to load until the login screen appears. Select the login button in the top right corner of the page. A pop up will appear.

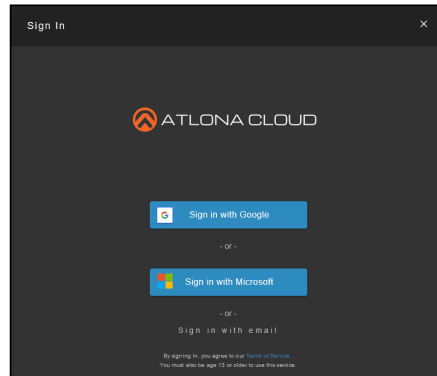

There are three options to login: Sign in with Google, Sign in with Microsoft, or Sign in with email.

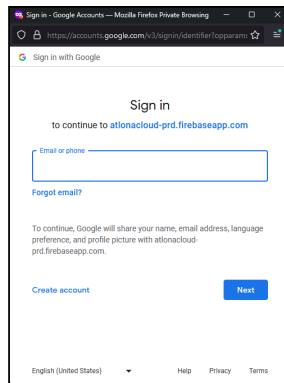
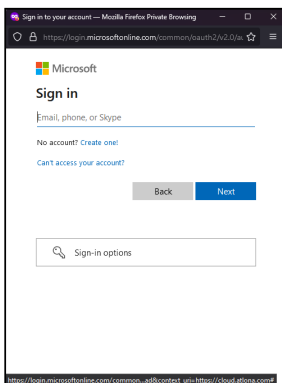

When selecting Google or Microsoft, a pop up will appear. Enter the account information and it will send a confirmation email or text (based on account settings).

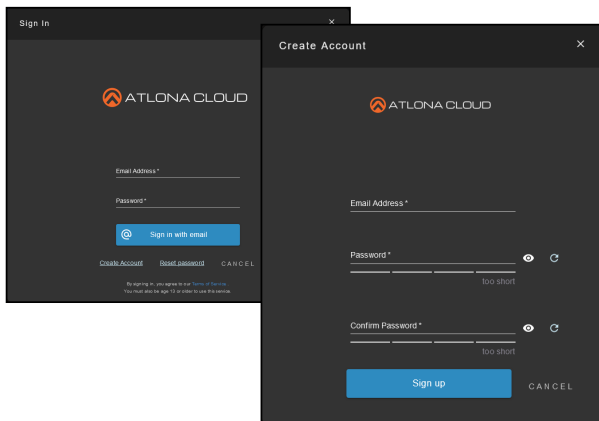

Sign in with email will require an email and password that has already been set up, if one has not been created, select the Create Account link below the blue button, a new screen will open. Once an email and password has been added, select the Sign up button. Once the account has been created, a confirmation email will be sent to verify the account.

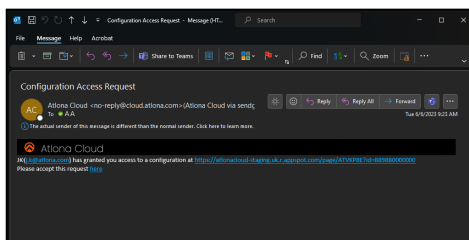

An email will be sent from the address no-reply@cloud.atlona.com. If it does not appear in the inbox within 5 minutes, check the Junk/Spam folder.

Select the here link to be redirected to a verify page.

The account is now ready for configuration.

Login for Configuration

When logging in the first time, if the unit has internet disabled, it will have a blank configuration page and a virtual VKP will have to be added manually. If the unit is in IoT mode, it will automatically link and register the unit.

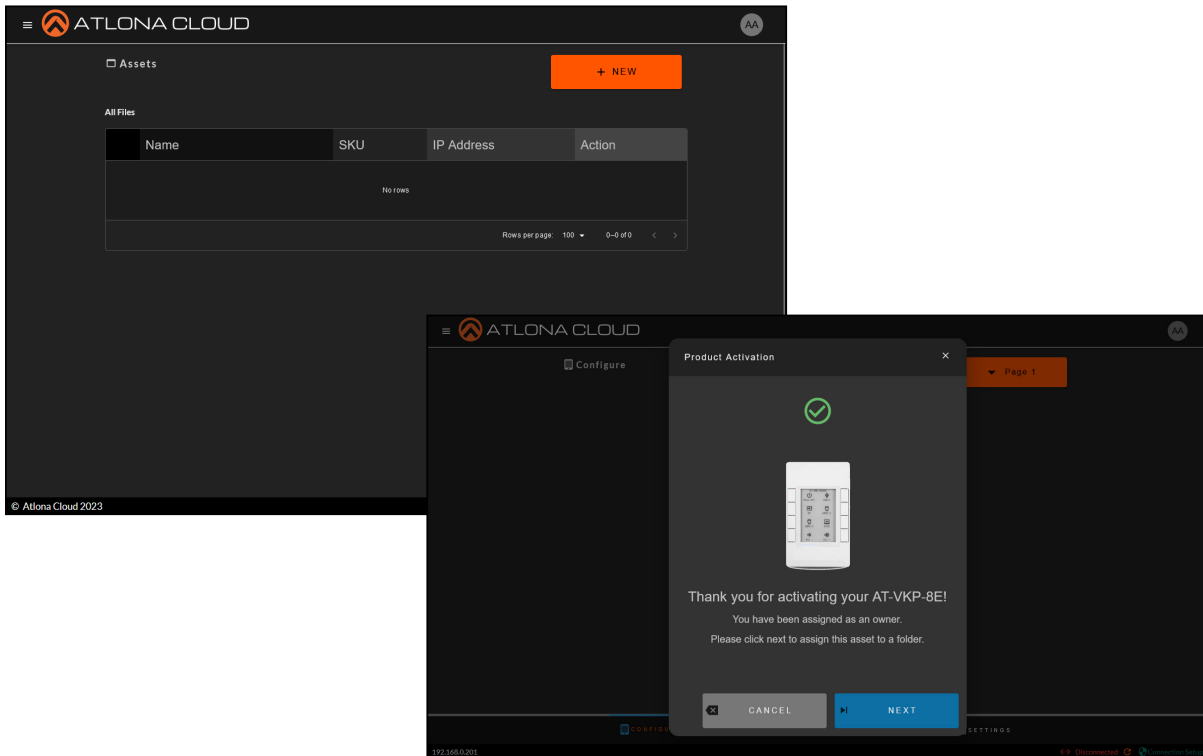

The unit is now ready for configuration.

Local Mode

While it is **recommended to use IoT Mode**, Local Mode is available if on a secure network, which has no internet access. Local mode provides access to an internal webUI. Within the webUI control configuration can be uploaded/downloaded, firmware updated, network settings changed, API mode, cloud opened, and certificates rebuilt/downloaded.

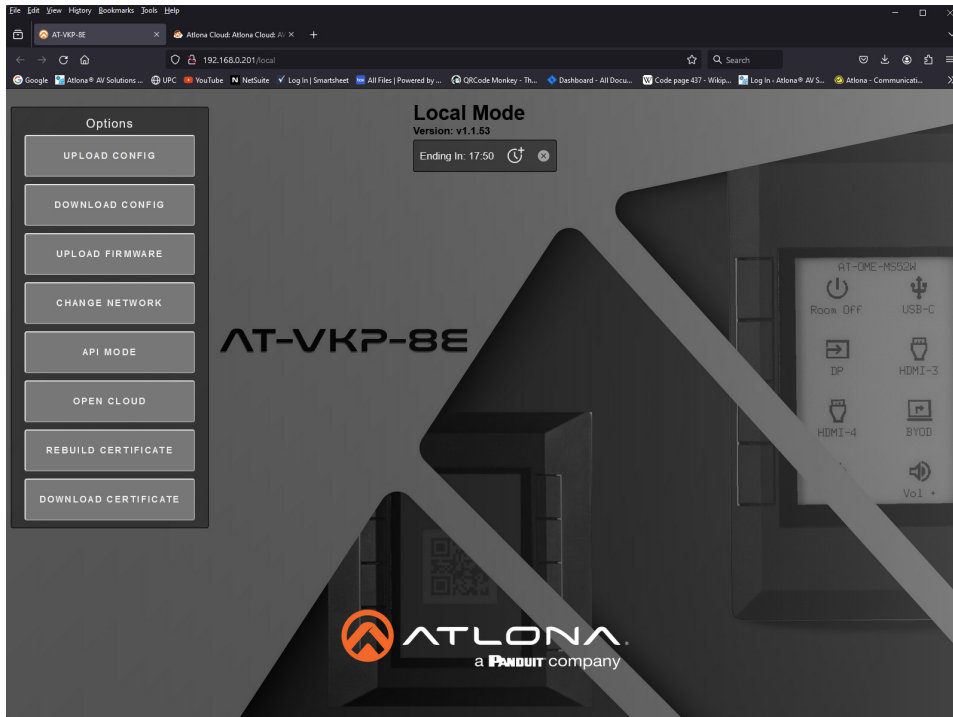

Local Mode has a 20 minute automatic time out. The countdown timer will be displayed at the top under the firmware version. If the timer is running out and more time is needed, press the clock icon next to the time and it will reset back to 20 minutes. If local mode is no longer needed, press the X button after the clock icon and it will set the unit into IoT Mode.

Upload / Download Config

Control configuration cannot be done locally and must be set up through cloud. The control configuration can then be downloaded from cloud to the local computer, then uploaded to the VKP manually through the **Upload Config** button. The current control configuration on the VKP may also be downloaded to the local computer from the current VKP to be transferred to another VKP or uploaded to a VKP in the cloud, using the **Download Config** button.

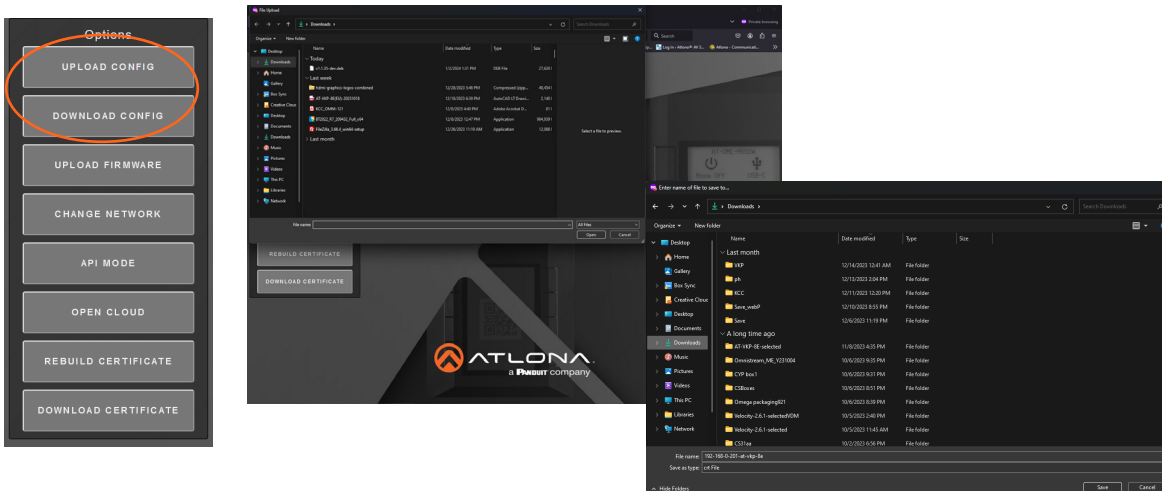

Upload Firmware

Download the latest firmware from the firmware tab at <https://atlon.com/product/at-vkp-8e> or from the settings tab on the device configuration located at cloud.atlon.com.

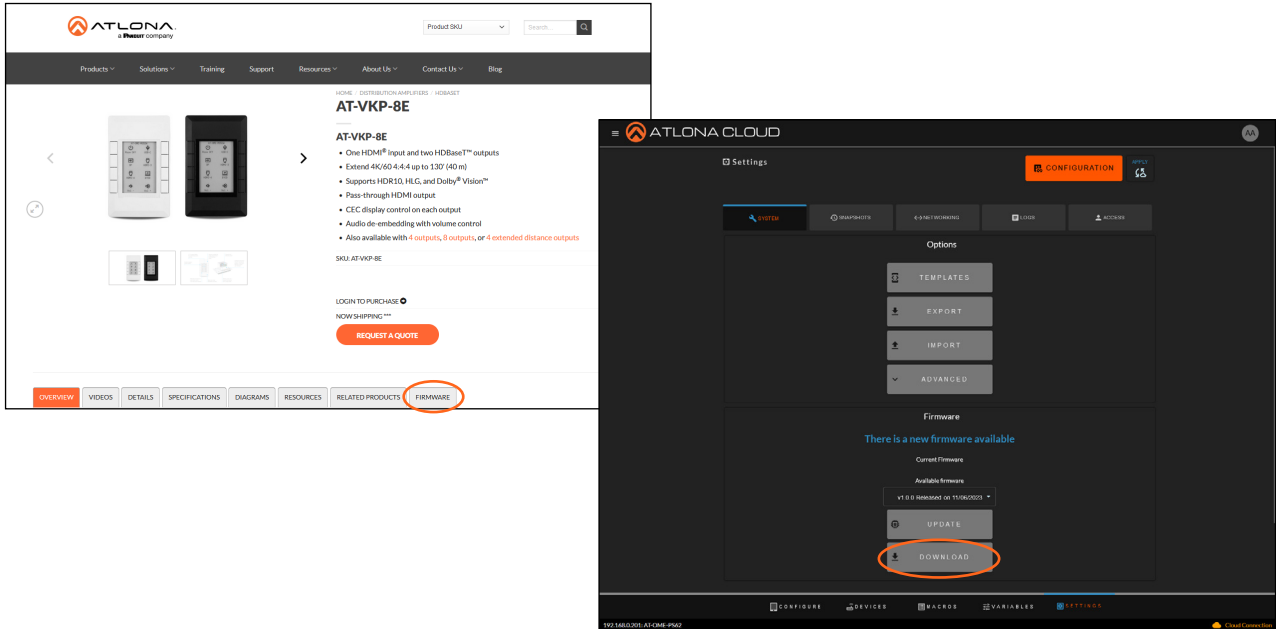

Once saved to the local computer, press the Upload Firmware button and select the file. It will show a progress bar as the unit updates. Once done, the unit will restart. When updated, the unit will set itself to IoT mode by default. Switch it back to local mode if preferred by using the front panel buttons.

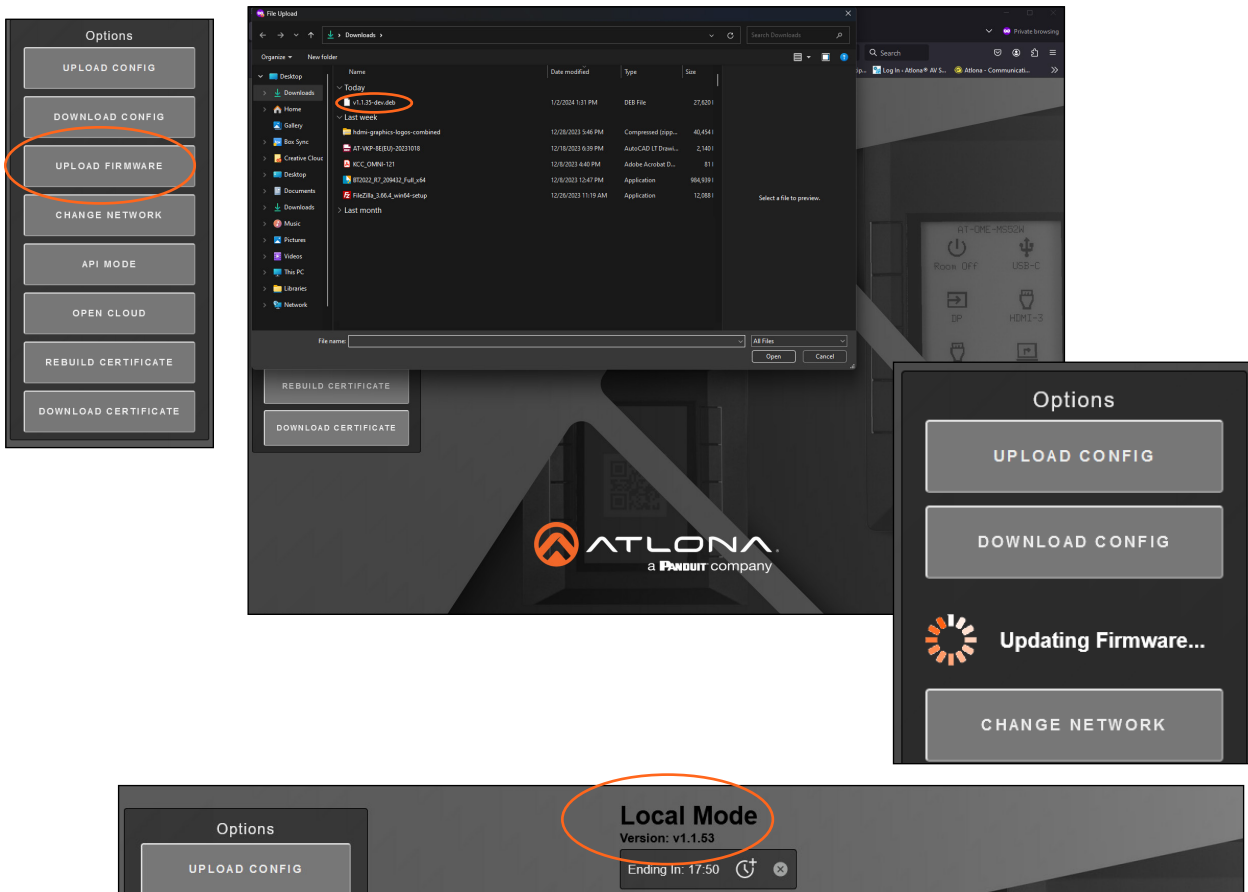

The firmware version will display in the center of the local webUI

Change Network

Select the Change Network button to pull up the different Intranet and Internet options. IP can be switched between DHCP and static or the unit removed from speaking outside the network.

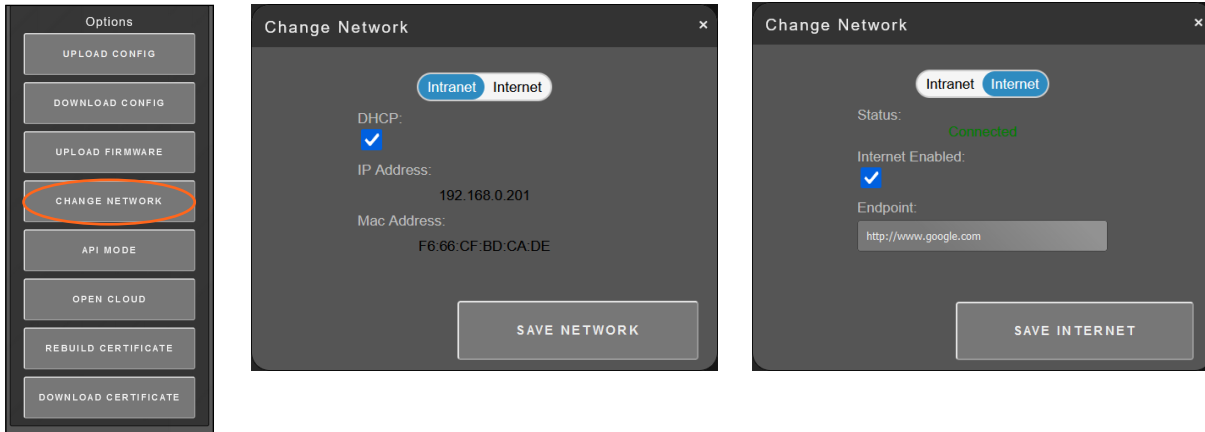

To switch from DHCP to Static IP mode, select the checkbox next to DHCP. New options will appear under the checkbox. Fill in at least IP Address, Netmask, and Gateway. DNS 1 & 2 are optional. Press Save Network when finished. The unit will switch IP, then restart. If the unit doesn't come right back up, press a button on the unit to wake it.

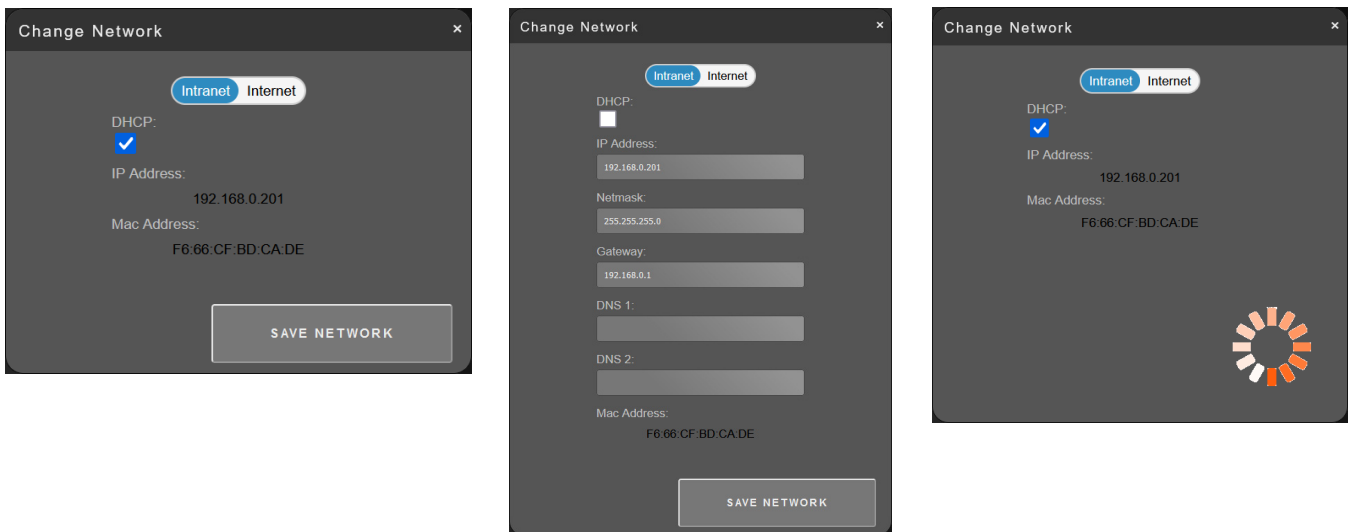

If the unit is being used on a secure network, the outside access of the unit can be shut off, but selecting the checkbox under Internet Enabled. Once selected, press save. The unit can take up to 2 minutes to switch, it will show the progress at the bottom of the window. Once complete, the unit will be unable to access outside the network.

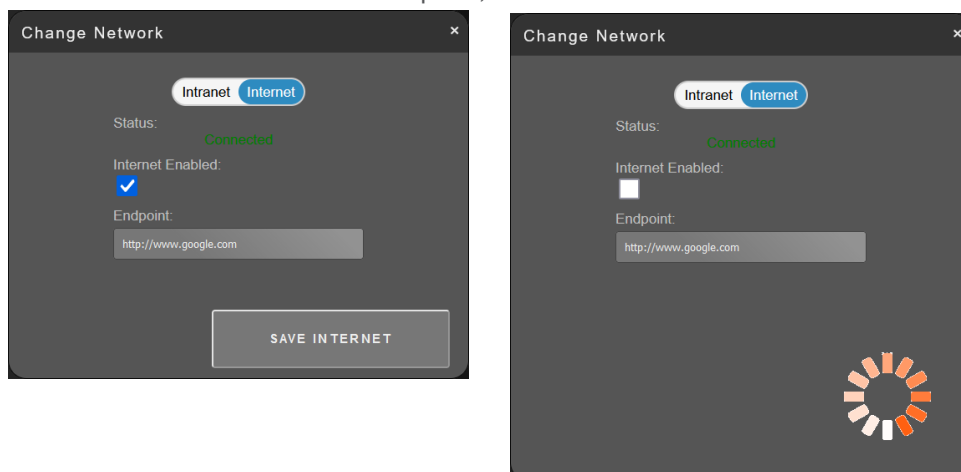

API Mode

Set the unit up to work with the Velocity Gateway on the network. Set the Gateway IP to match Velocity and press save.

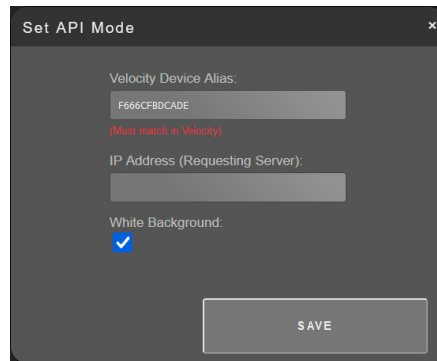
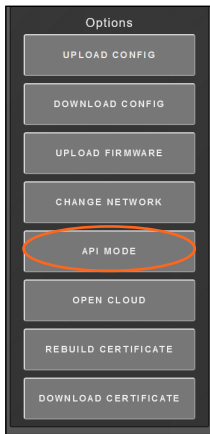

Open Cloud

Select the Open Cloud button to bring up cloud.atlona.com in the current browser.

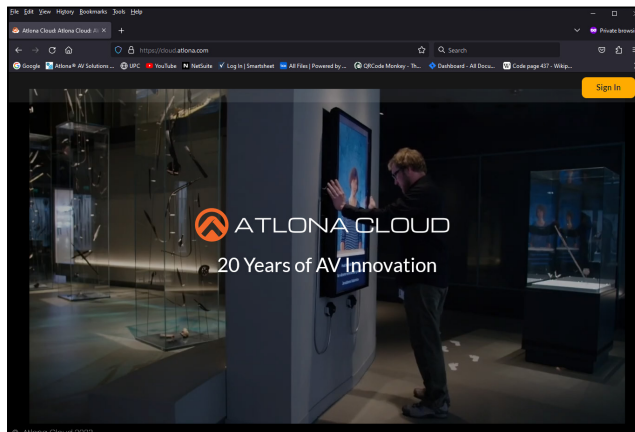
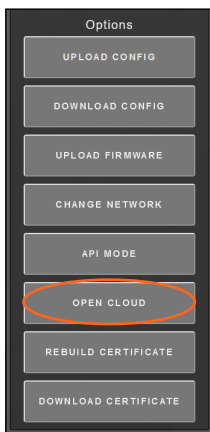

Certificates

Rebuild Certificate

If communication between VKP and other devices is stopped or has an error, rebuilding certificates may help. Select Rebuild Certificates, a popup will appear. Select Rebuild and a popup with a rebuilt message will appear. Select OK and the unit will restart.

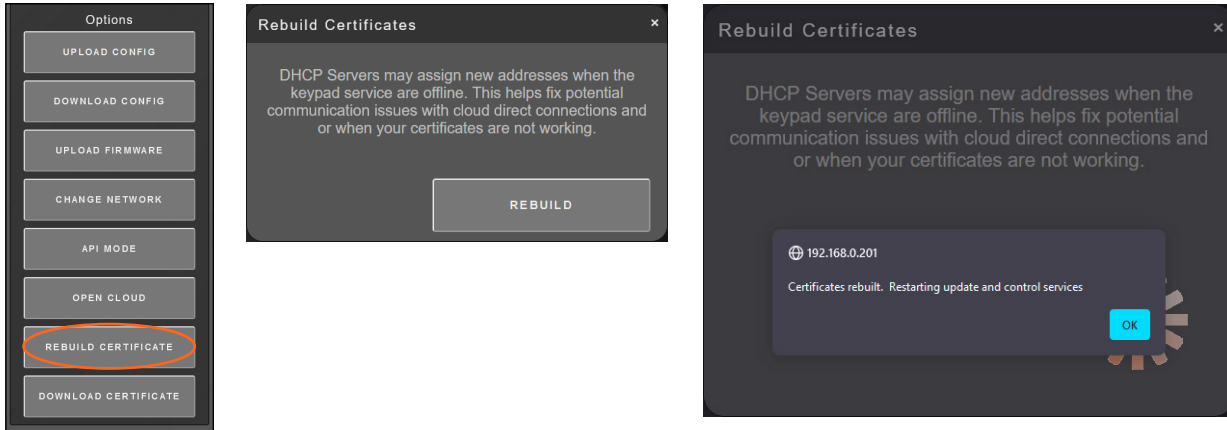

Save Certificate

To get the certificate of the VKP, press the Download Certificate button. A pop up will appear. Select the folder on the local PC to save the certificate to and press save.

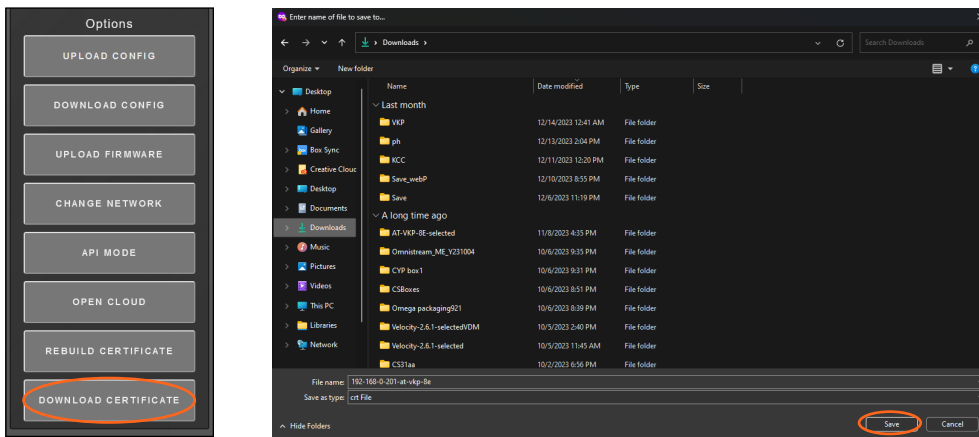

When internet has been disabled, the certificate can be used to allow configuration through cloud on a PC that has LAN connection to the VKP's closed network and a second connection to the internet. Follow the steps outlined in cloud, using the green **Connection Setup** button in the bottom right corner.

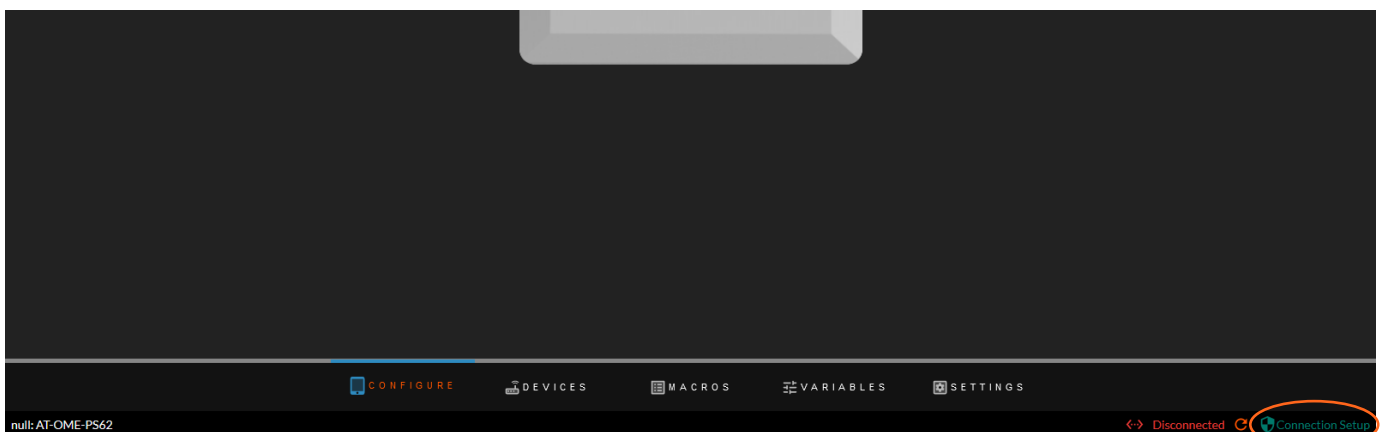

Control Configuration

After login there are two options depending on the VKP-8E's internet status.

IoT Mode Template Selection

When the unit logs in, it will pop up with a product activation window.

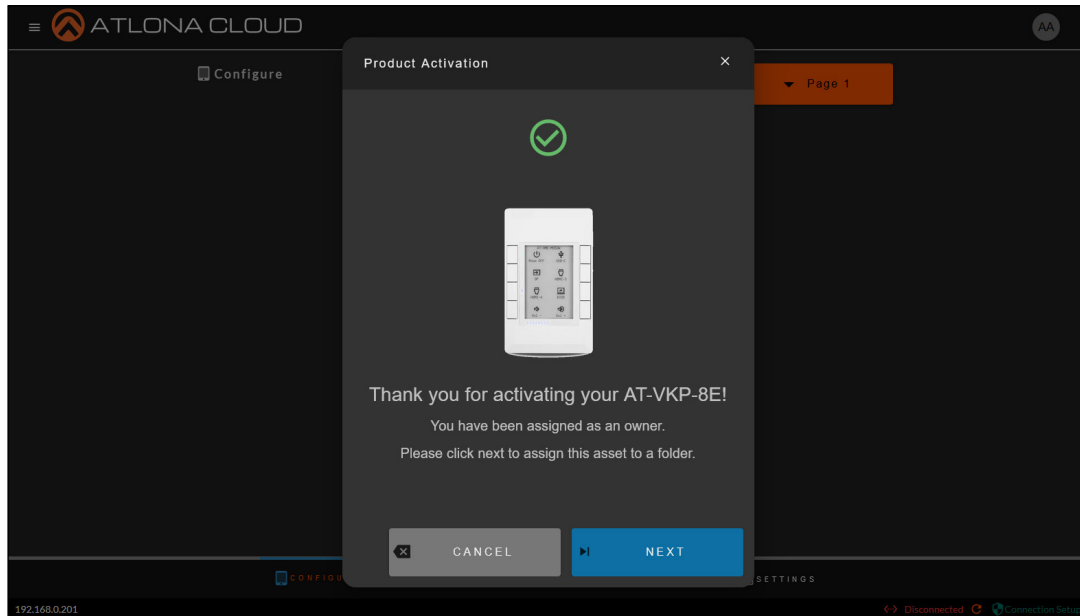

Select Next to continue to IoT control set up. A new pop up will appear.

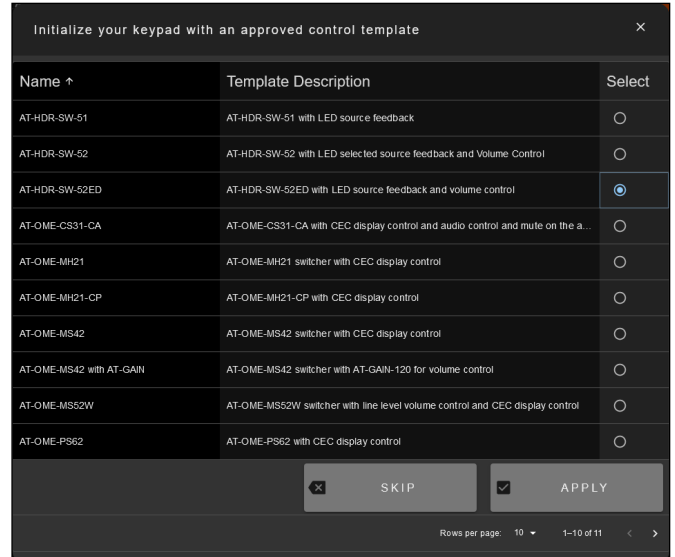
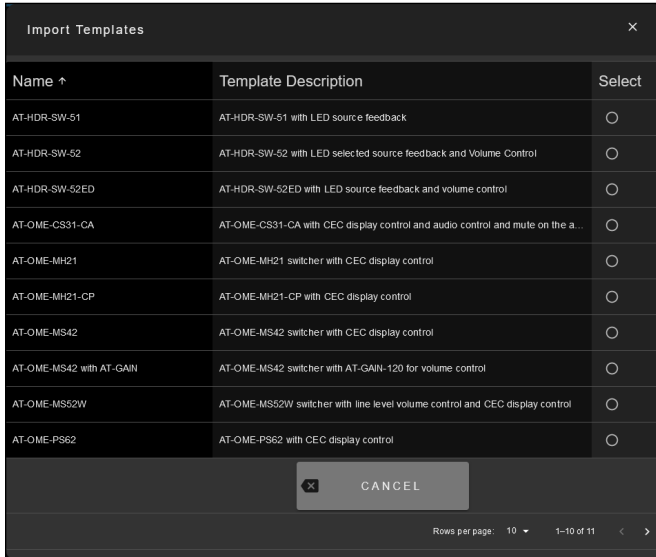

Select the Atlona device that will be controlled by the VKP-8E (more devices can be added later). An Apply button will appear at the bottom right corner, press it. A pop up will appear to ensure the correct device was selected, press OK. The current pop up will close and a small warning will appear as the template loads. Once finished it will go to a folder screen.

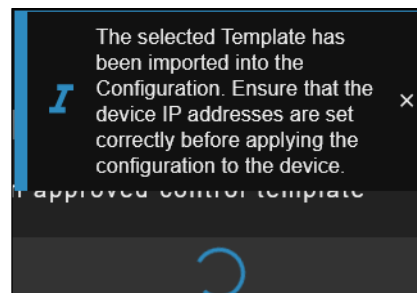
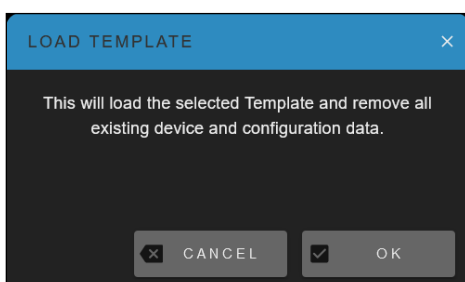

Control Configuration

Select the folder with the + symbol to create a new project folder. A new pop up will appear. Enter a name in for the folder. This could be named after a room, a site, or anything that will help with organization. Once the name has been entered, press the Save button. The folder will appear on the folder screen. Select the folder, if not already selected, and press the Next button.

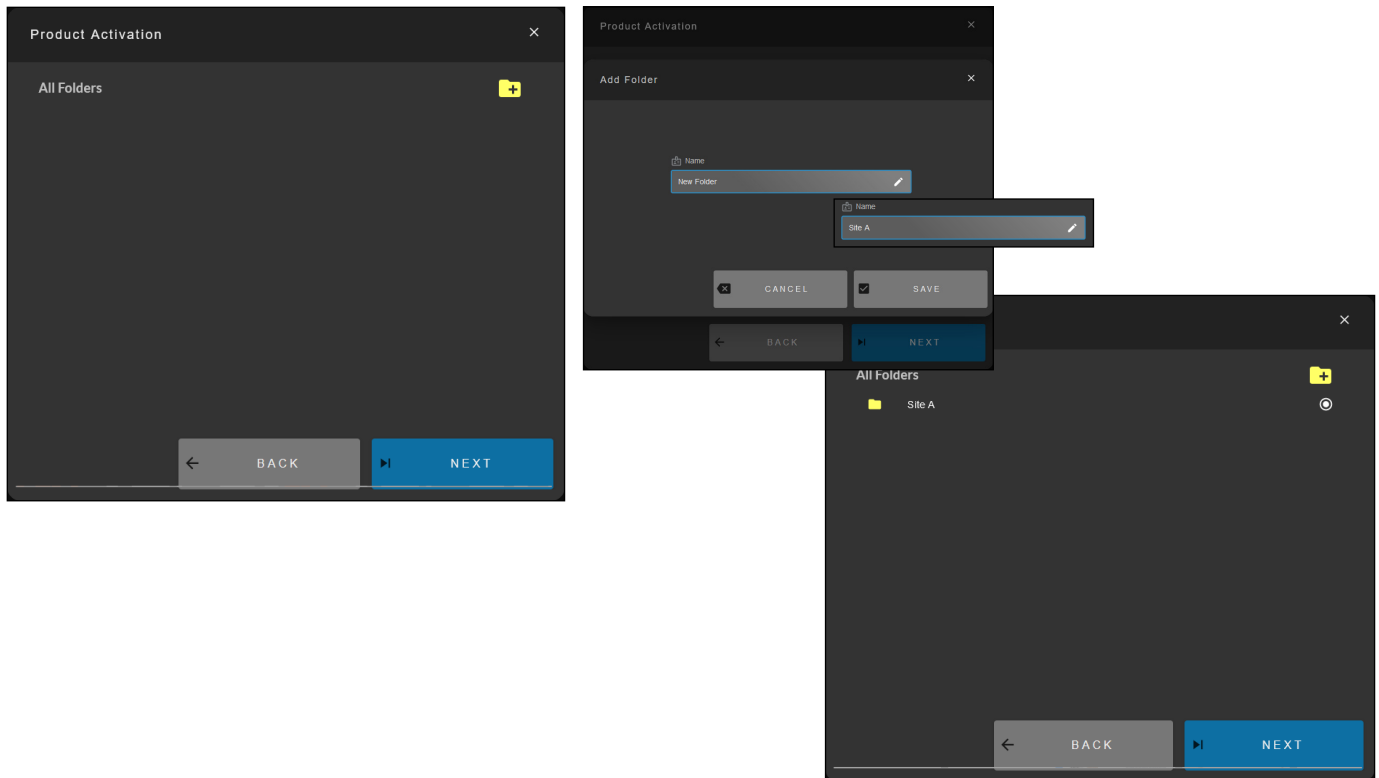

A VKP page will appear with a preloaded template of the Atlona device that was selected previously.

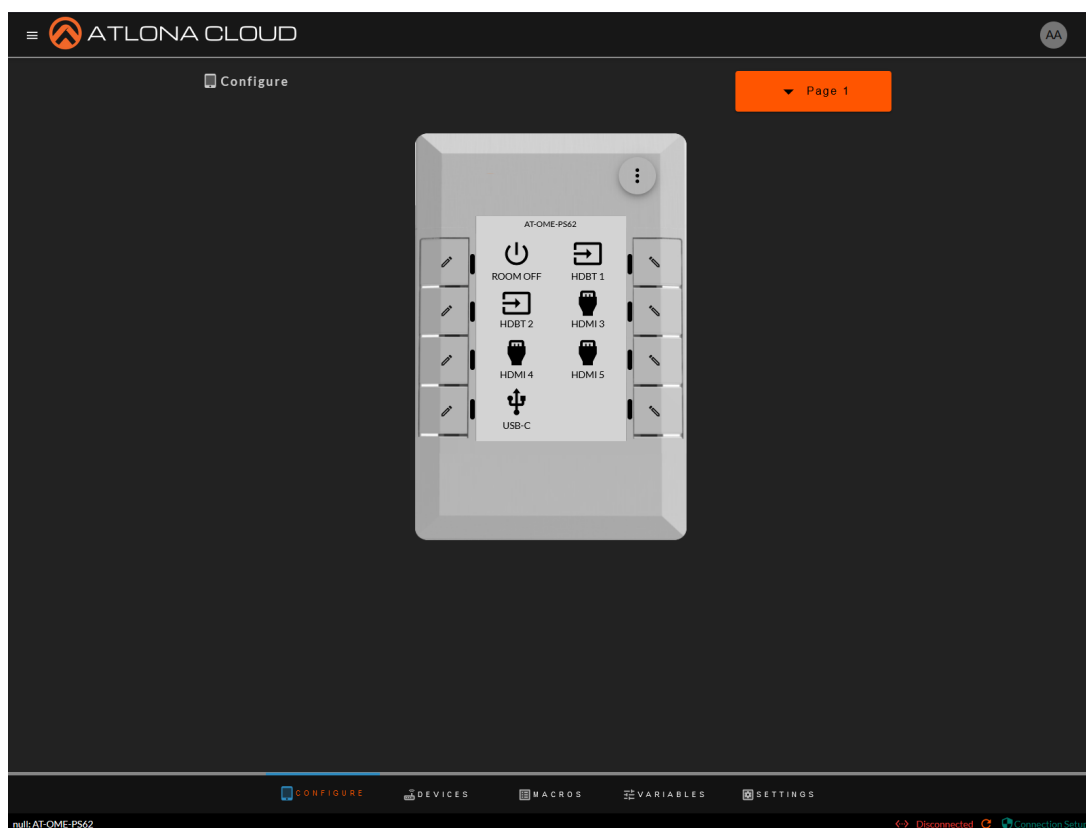

Virtual Template Selection

When the unit has internet disabled, cloud will load to a generic page. A virtual VKP will need to be added. Select the + New button to add a VKP-8E. A drop down will appear, select Virtual Asset. A pop up will appear.

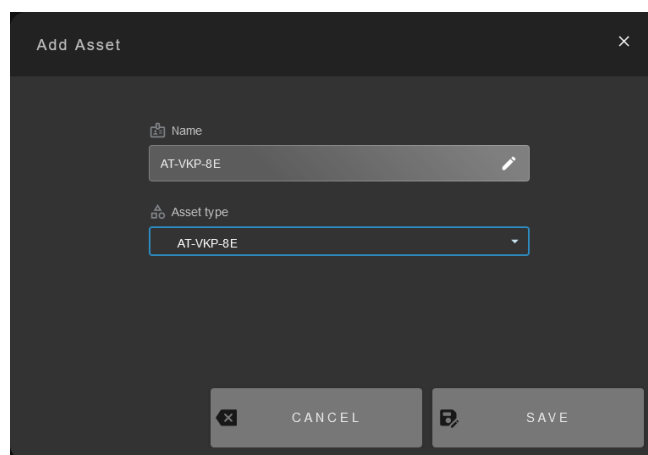
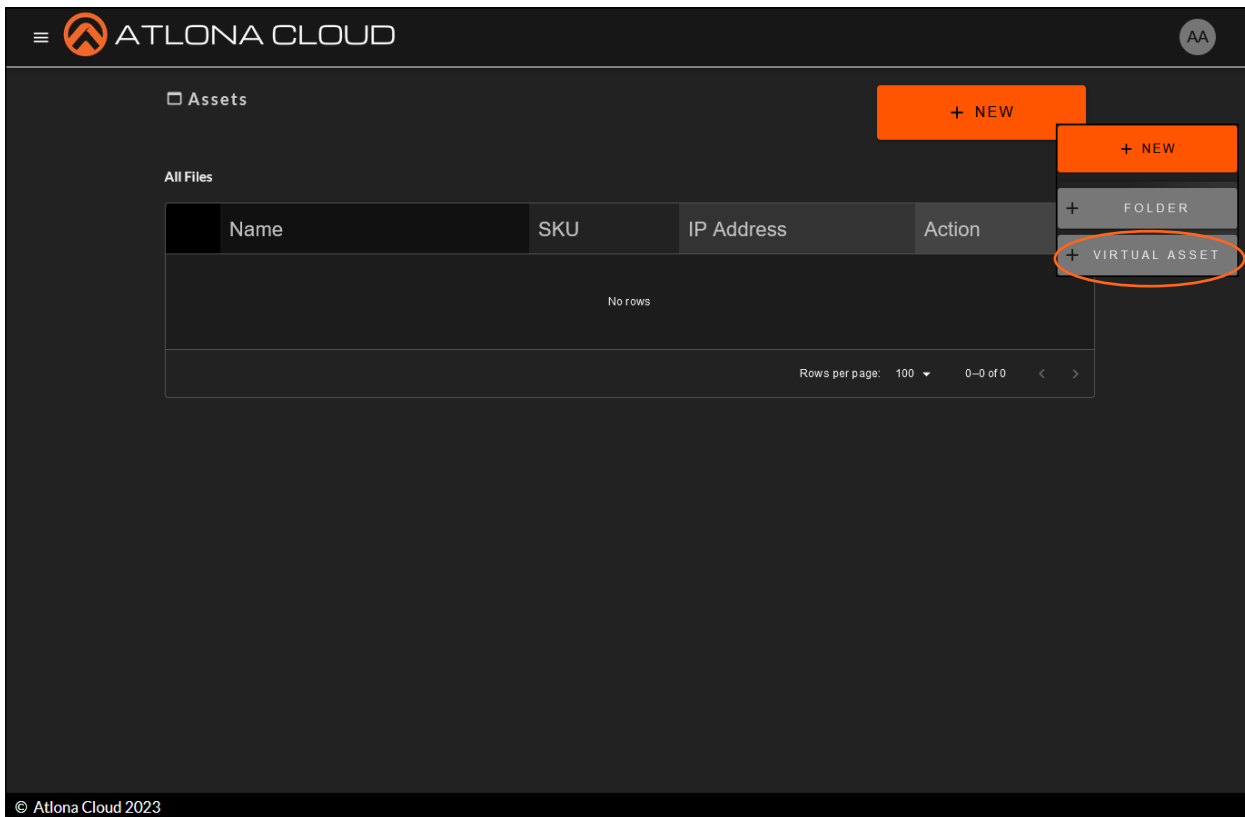

Provide a name for the unit (It can be just AT-VKP-8E, but providing a name will allow easy way to differentiate between multiple units. Select OK and the template selection will appear.

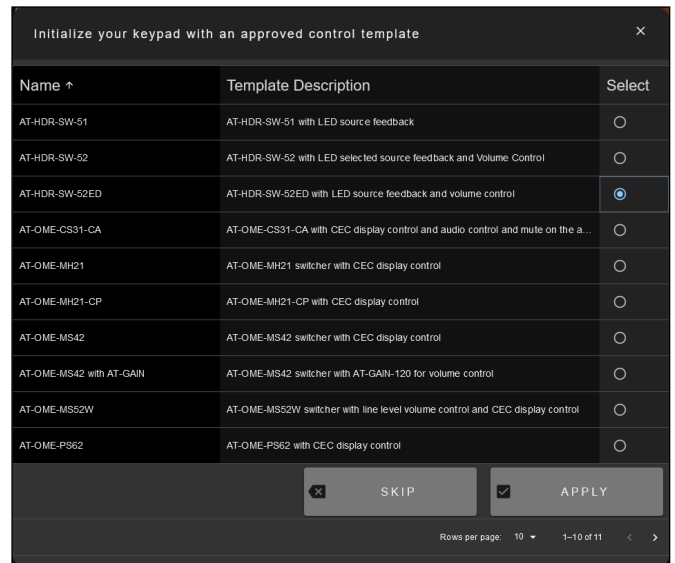
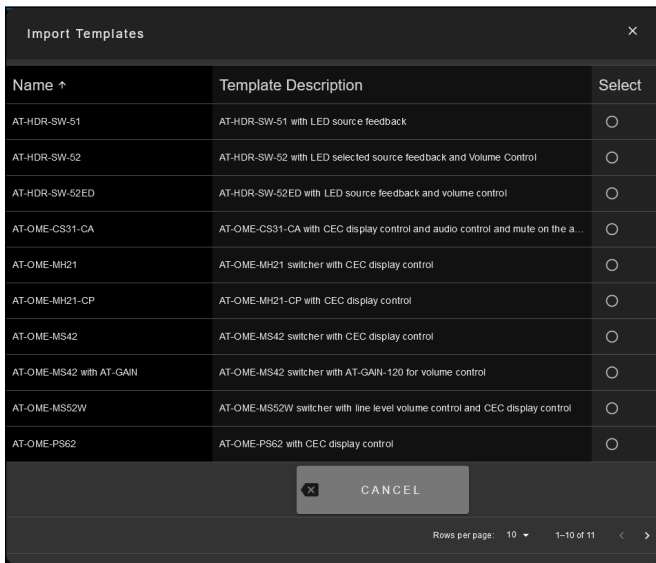

Select the Atlona device that will be controlled by the VKP-8E (more devices can be added later). An Apply button will appear at the bottom right corner, press it. A pop up will appear to ensure the correct device was selected, press OK. The current pop up will close and a small warning will appear as the template loads.

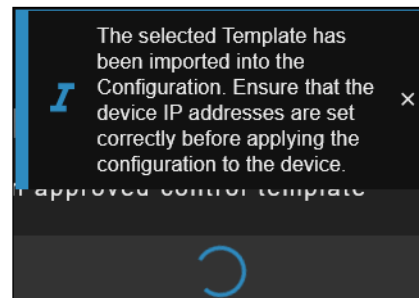
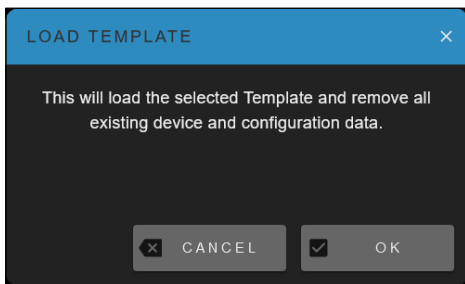

A VKP page will appear with a preloaded template of the Atlona device that was selected previously.

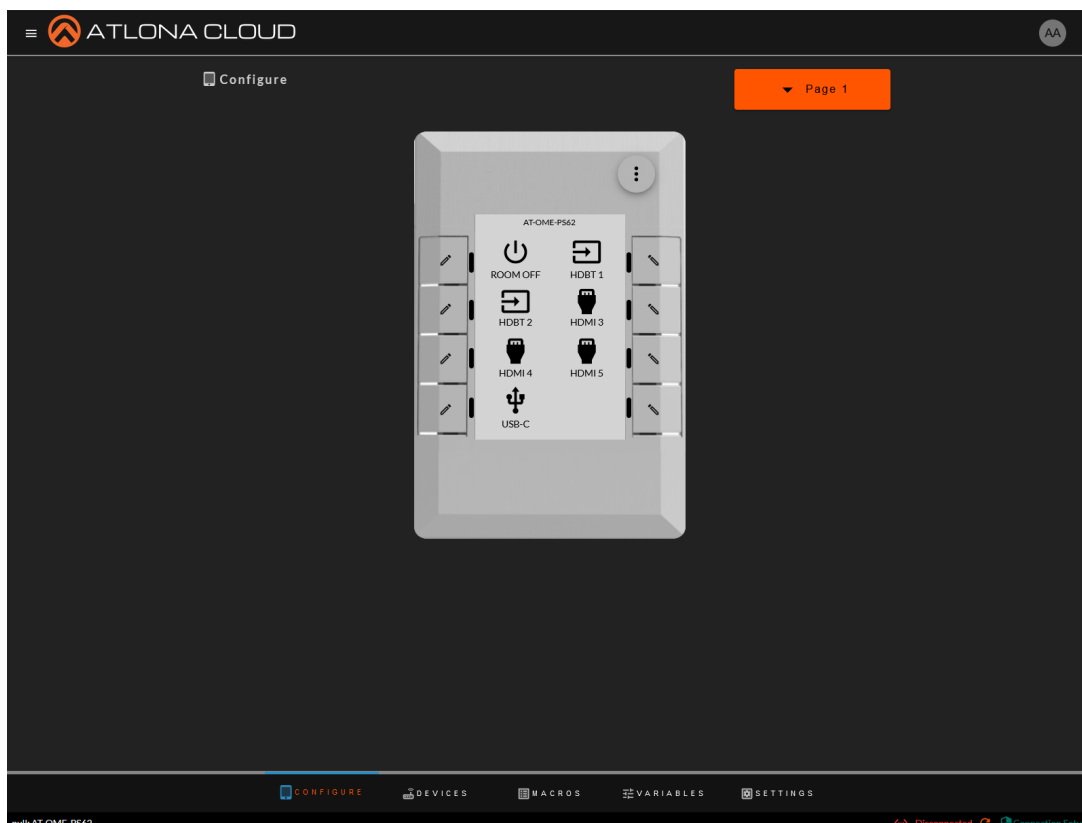

Assets

For easy organization, folders for sites, buildings, and rooms can be set up. Select the ☰ button in the top left corner of the cloud. A menu will open, select assets from the menu.

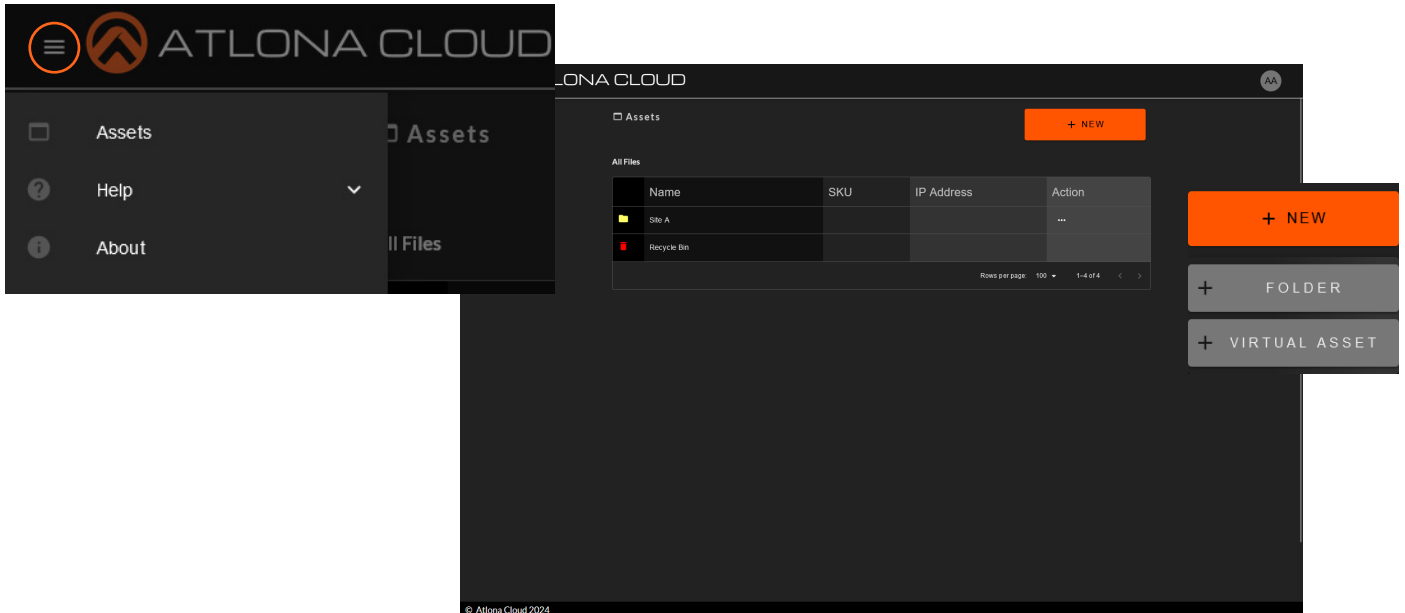

Add New

Press the **+New** button to add a virtual VKP-8E or a folder. Pop ups will appear when selected. Enter a name for the folder or VKP-8E.

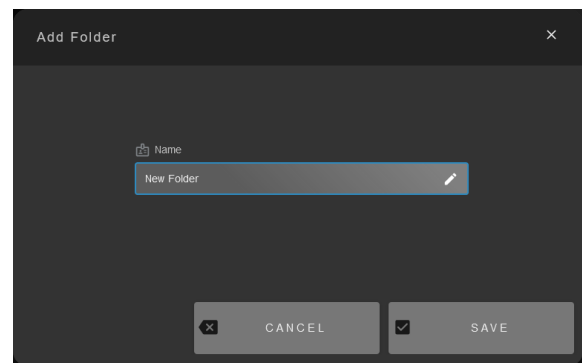
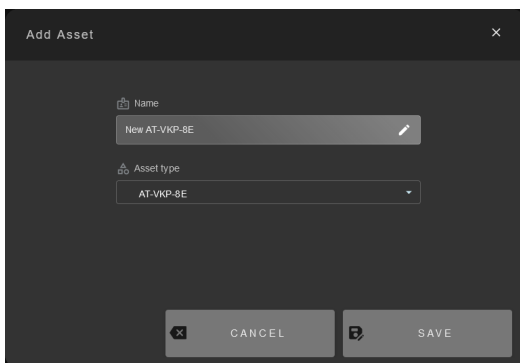

Once named, press the save button. The new item will appear in the files. Once added, they can be edited, moved between folders, shared with outside users, or deleted. Use the ... button to open the menus.

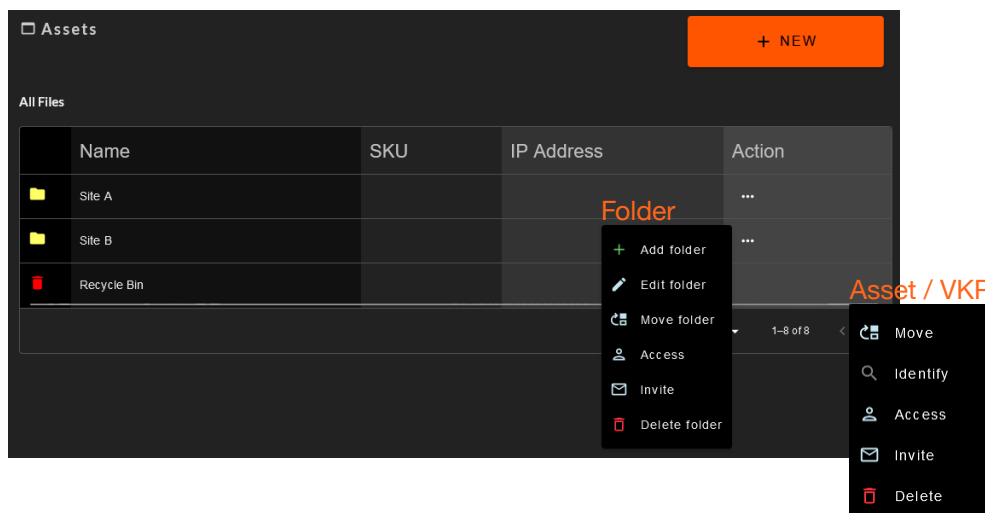

Add Sub Folder

Select Add Folder from the folder drop down. A pop up will appear to allow a sub folder to be added to the selected folder. Enter a name and press save. This will open the sub folder.

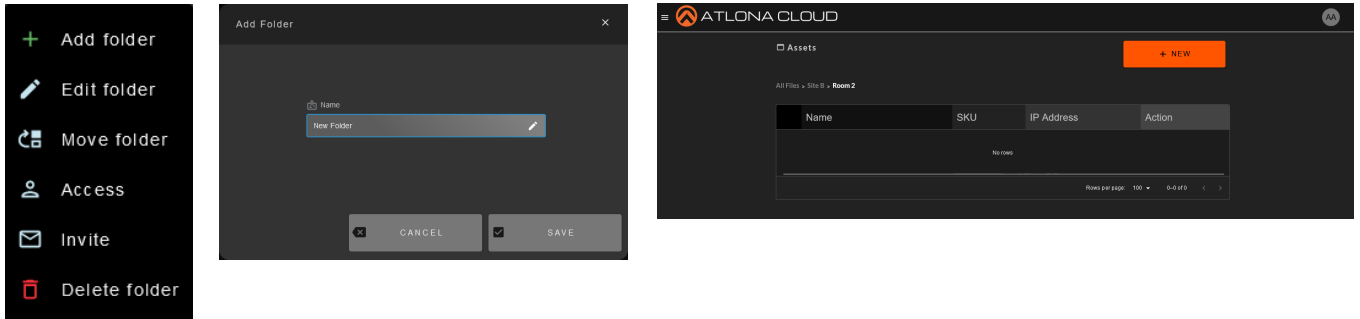

Edit Folder

Select Edit from the folder drop down. A pop up will appear to allow the folder to be renamed.

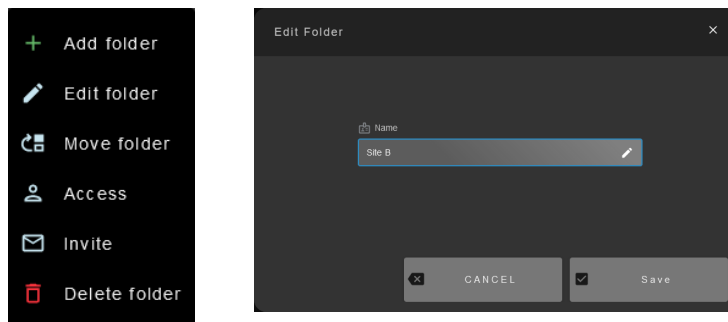

Move Folder/Asset

Select move to folder on either folder or asset to move between rooms. A pop up will appear. Select the folder that the device or folder to move to and select Move.

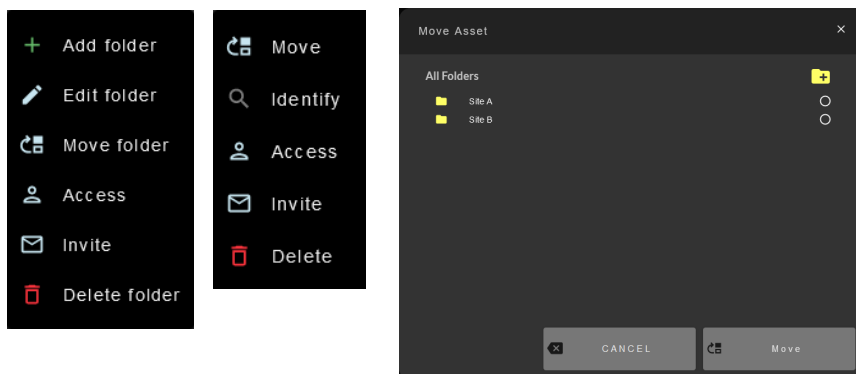

View Allowed Users

Select Access to see which users have access to the folder or device. A pop up will appear to show all users.

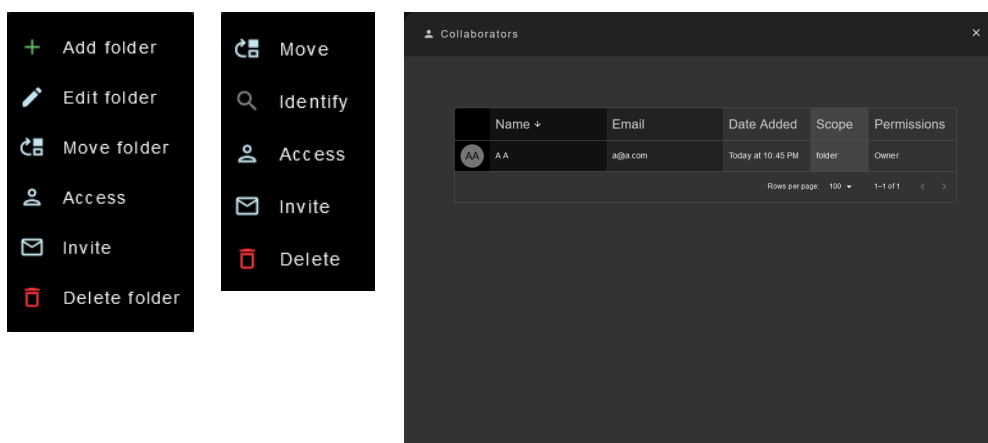

Invite Users

If a device or folder needs to be shared with a user, the new user can be invited to access using the Invite option in the drop down menu. A pop up will appear. Enter the user's email, then select a role. Once done, select Invite to send an email.

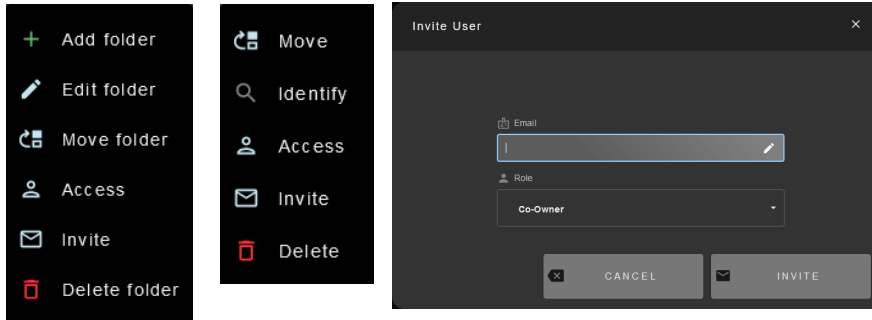

- Co-Owner - Has access to delete, edit, and invite more users.
- Editor - Has access to add/edit folders and/or devices.
- Viewer - Only has access to view the devices and/or folders.

Delete Folder/Asset

If a folder or device is no longer needed. Select the Delete option. A pop up will appear. Press Ok to confirm the deletion. The pop up will close and the device/folder will no longer be in the list.

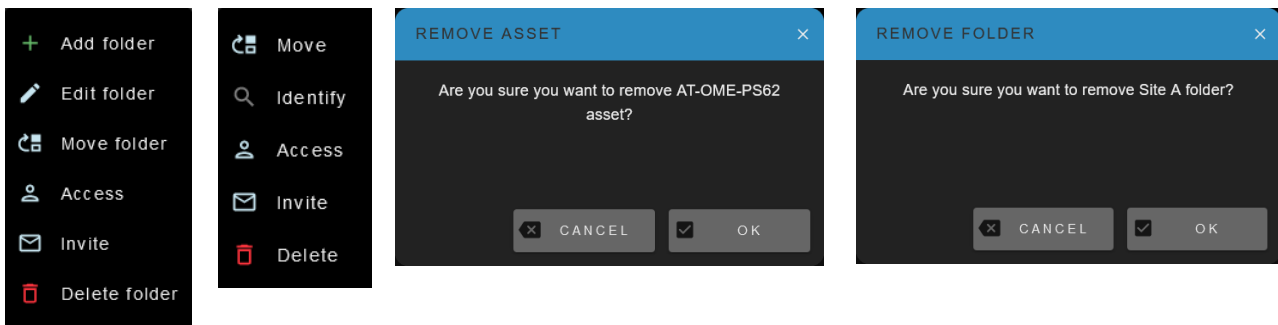

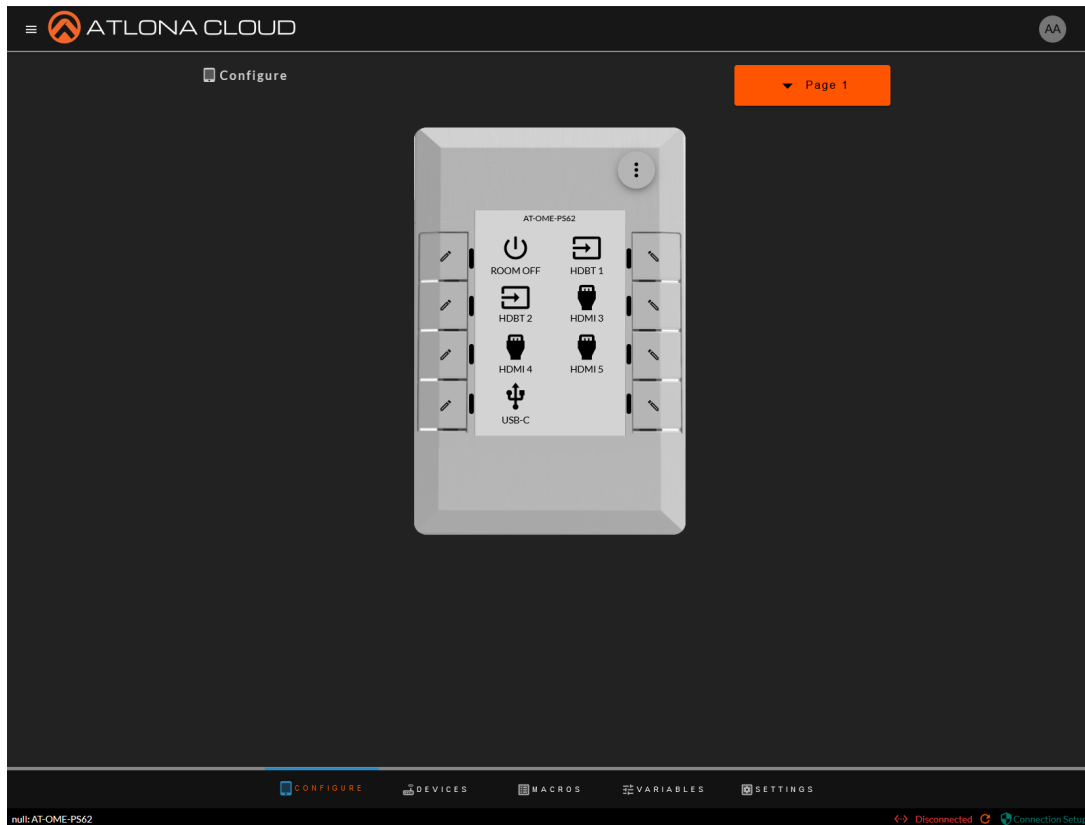

Settings

It is best to go through settings and ensure everything is up to date and network settings are correct. Select Settings from the bottom navigation. It will open to System.

System

Templates - Select this button to override the current device's configuration of the VKP-8E. This will erase any settings that have been set already.

Export - This will create a file to save to the local PC to be uploaded to the VKP-8E when in local mode.

Import - Use a previously created file from the local PC to override the current set up.

Advanced - Select this button to expand for extra options: API Mode, Config Reset, and Unregister.

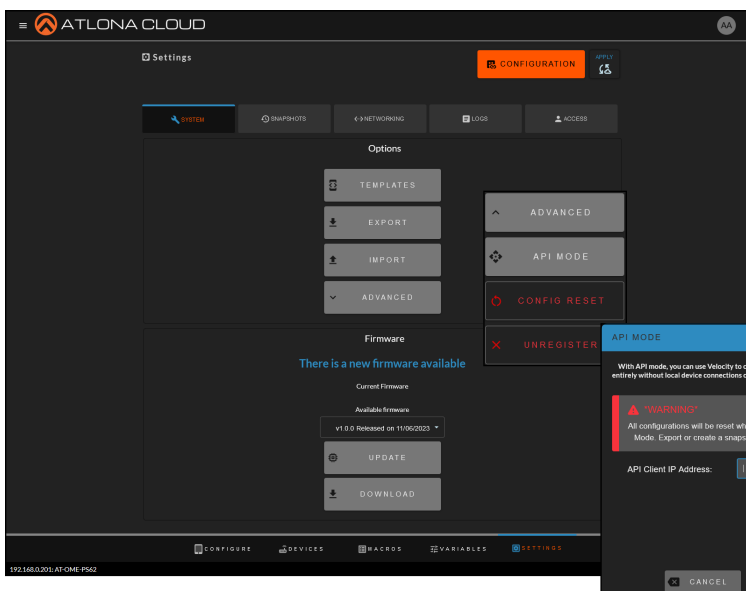

- **API Mode:** Set the unit up to be controlled by Velocity Gateway. Set the IP of the gateway and press OK. All settings will be reset.
- **Config Reset:** Set all the unit options back to default.
- **Unregister:** Unregister the VKP-8E from cloud.

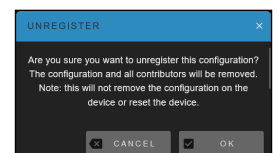
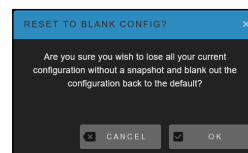
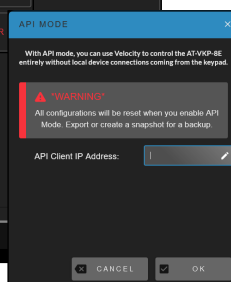

Snapshots

Different snapshots can be saved as the unit is being configured and set up. Select +Add Snapshot to save a current snapshot of the current configuration.

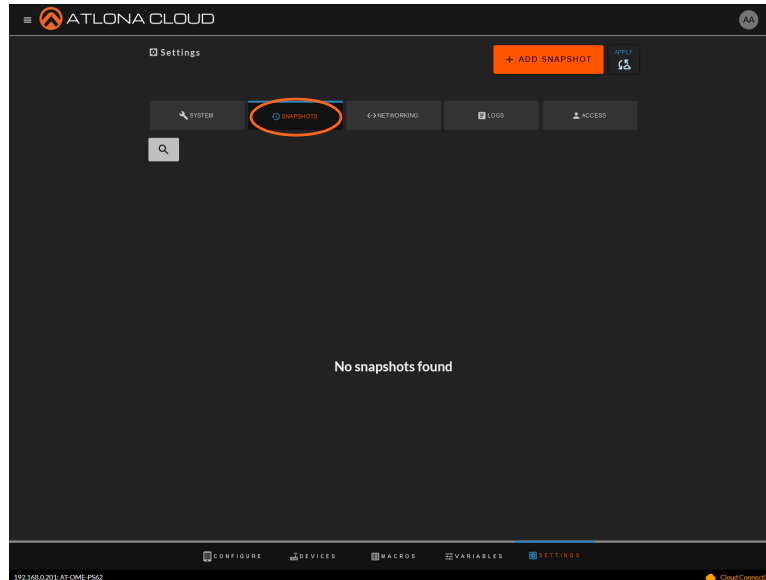

Networking

Internet Status - Provides a color coded view of the current status.

DHCP - Use this slider to switch between DHCP and Static. Provide IP address, Netmask, and Gateway for static IP.

MAC Address - Displays the unit's MAC address.

SSH Server - Enable or Disable this setting for linux access.

RS-232 Security and Settings - Enable or Disable this setting for device control through RS-232. Set the baud rate, parity, data bits, and stop bits of the unit to be controlled.

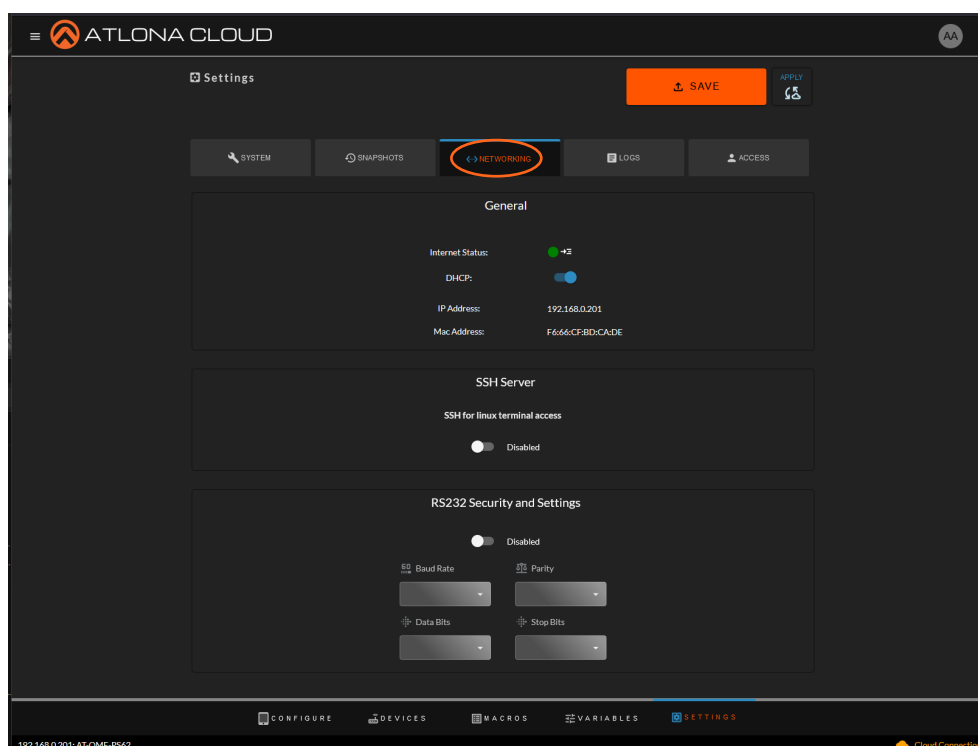

Logs

As the unit is sending and receiving information from the control devices, logs will be created. Select the download button to go through the logs. Each device can be selected to see individual logs.

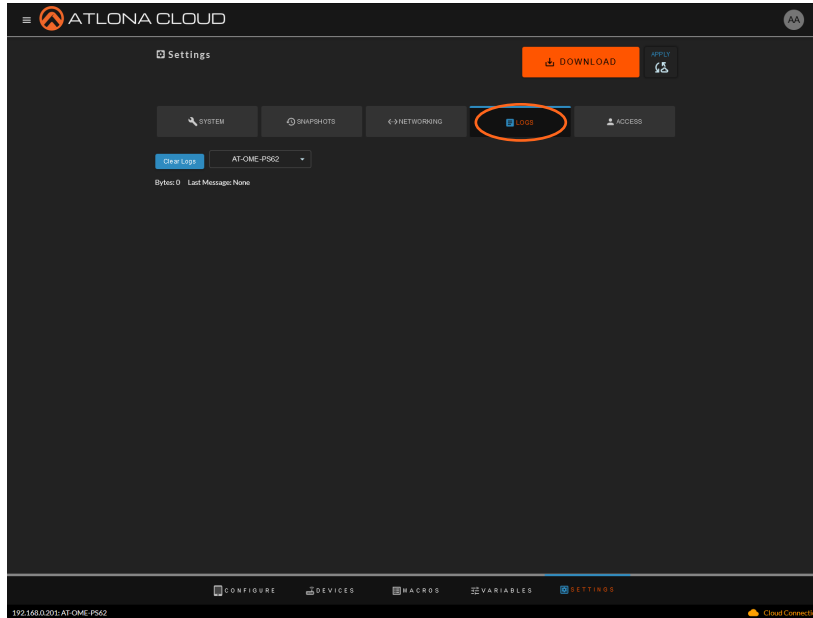

Access

Set up the users to be allowed access to the current device for control and configuration. Select the Invite button, add the user's Email, then provide a role.

- **Co-Owner:** This role can make changes to setup, configuration, etc, as well as delete devices.
- **Editor:** This role can make changes to setup, configuration, etc but cannot delete devices.
- **Viewer:** This role can view any of the configuration but can make no changes.

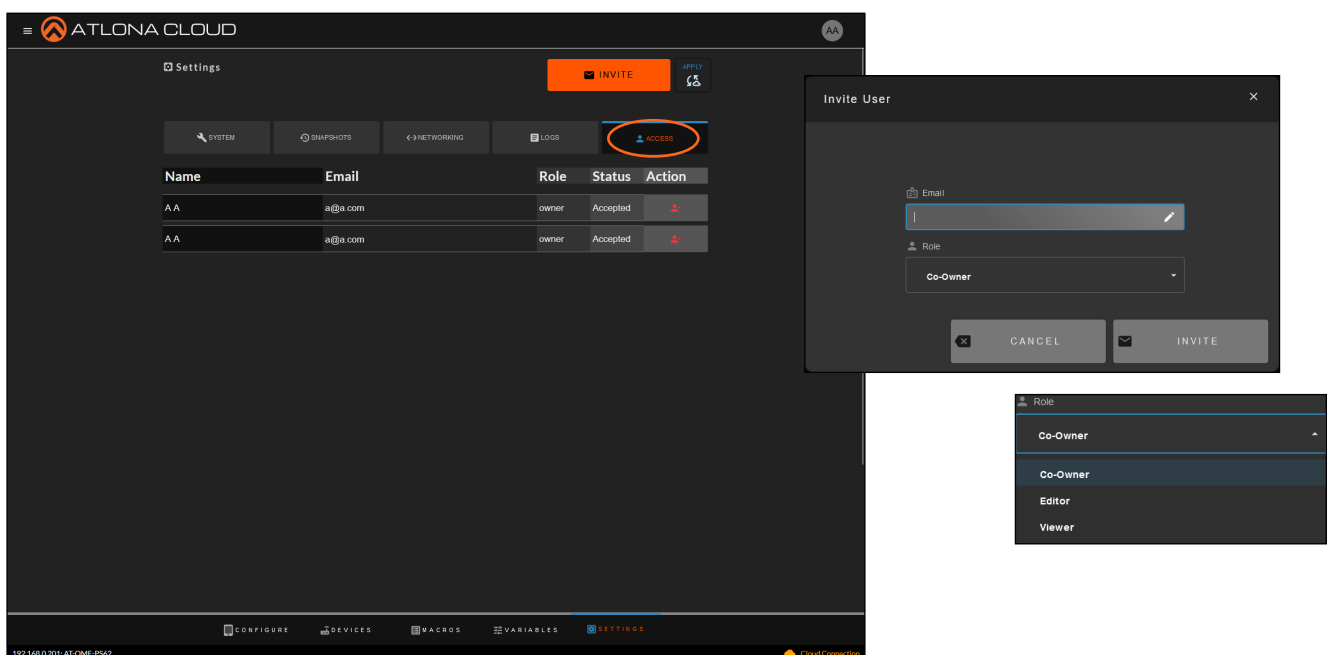

Devices

Before starting the full control set up, it is best to go through and make sure all units the VKP-8E will control have been added. Select Devices in the bottom Navigation.

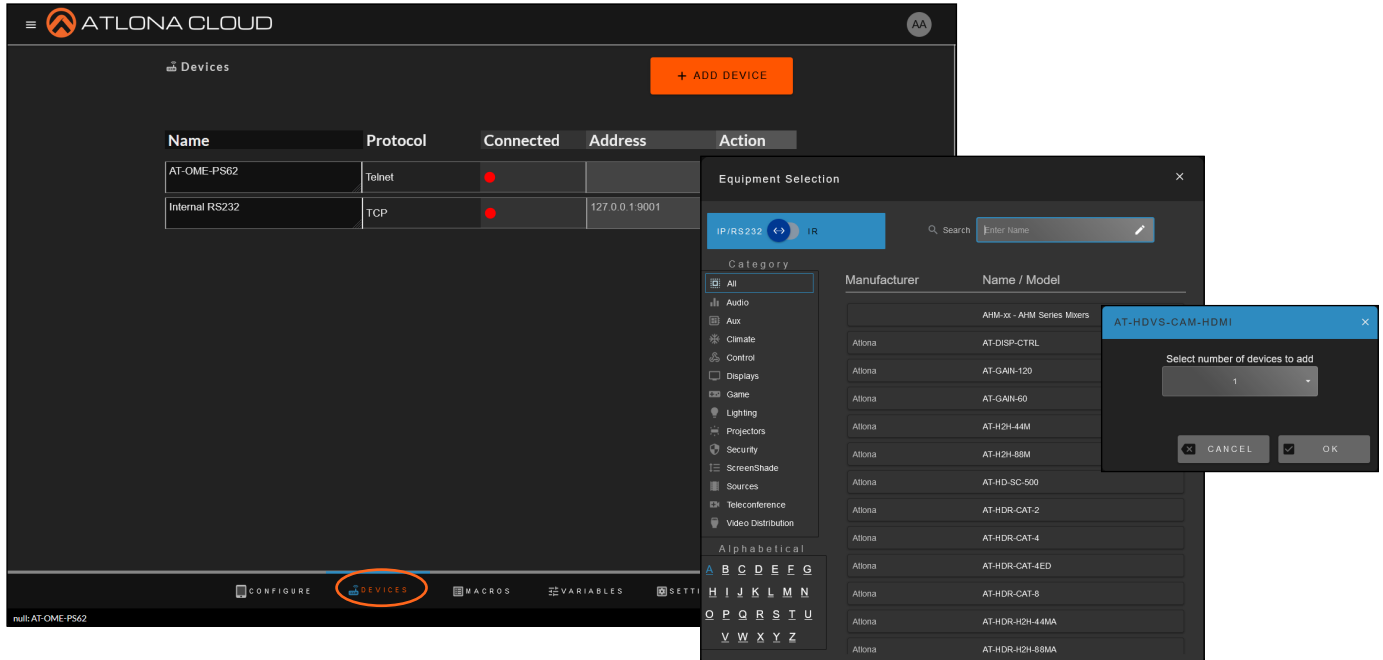

- Select the +Add Device button in the top right of the page. A new pop up will appear. More Altona devices and other preprogrammed devices can be selected from.
- Once selected, a pop up will appear for that device.
- Select the amount of units to add. The new device will appear in the devices screen.
- Repeat for control of up to 10 devices.

NOTE: If the device is not found, use the search bar to search the database for all available devices.

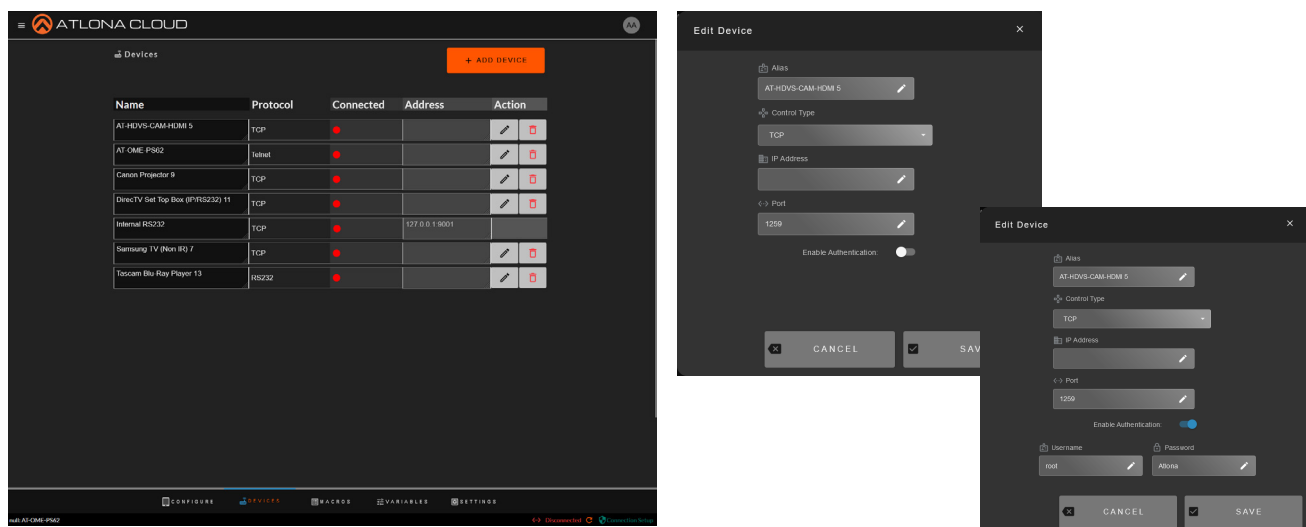

Once all the devices are added, go through and update them all to update the device name, set the control type (TCP or RS-232), add the IP address and port, and set the username and password if the device requires authentication.

- To get to the edit screen, simply press the edit pencil to the right of the device. A pop up will appear.
- Fill in the information.
- If the device has authentication, select the slider to enable username and password.
- Once filled in, select save and the device is ready for control.

Variables

Variables are functions that can be set and changed based on set events. These variables can be used to trigger macros or events.

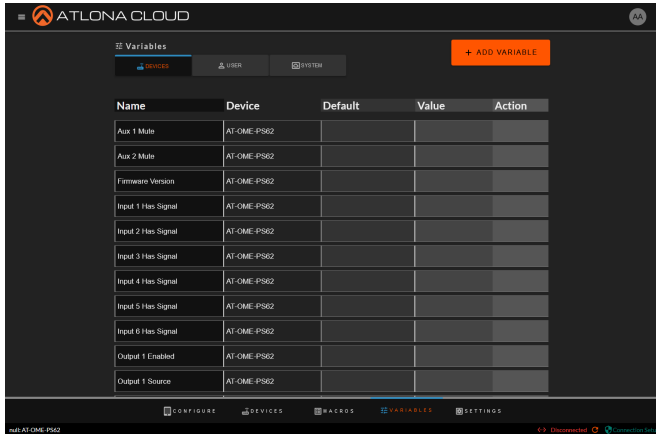

Name	Device	Default	Value	Action
Aux 1 Mute	AT-OME-PS62			
Aux 2 Mute	AT-OME-PS62			
Firmware Version	AT-OME-PS62			
Input 1 Has Signal	AT-OME-PS62			
Input 2 Has Signal	AT-OME-PS62			
Input 3 Has Signal	AT-OME-PS62			
Input 4 Has Signal	AT-OME-PS62			
Input 5 Has Signal	AT-OME-PS62			
Input 6 Has Signal	AT-OME-PS62			
Output 1 Enabled	AT-OME-PS62			
Output 1 Source	AT-OME-PS62			

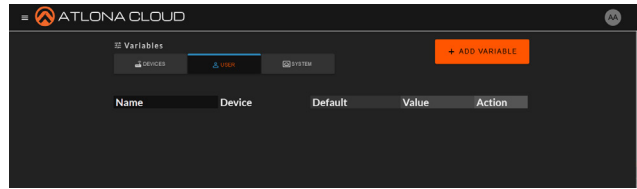

Name	Device	Default	Value	Action
------	--------	---------	-------	--------

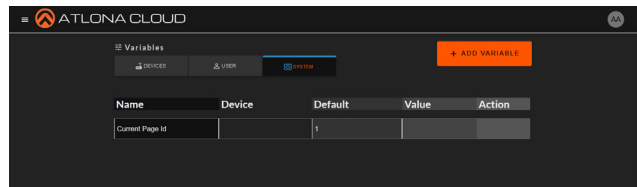

Name	Device	Default	Value	Action
Current Page Id		1		

There will be precreated variables based off of device APIs under Devices. User variables will be created when the +Add Variables is selected and a name and value are provided and saved. The system variables are precreated by cloud.

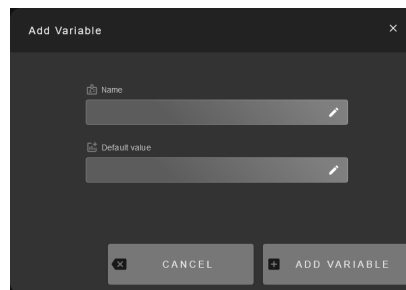

Add Variable ✕

✕ CANCEL
+ ADD VARIABLE

Macros

Macros and Events provides the ability to program and run different commands for each device.

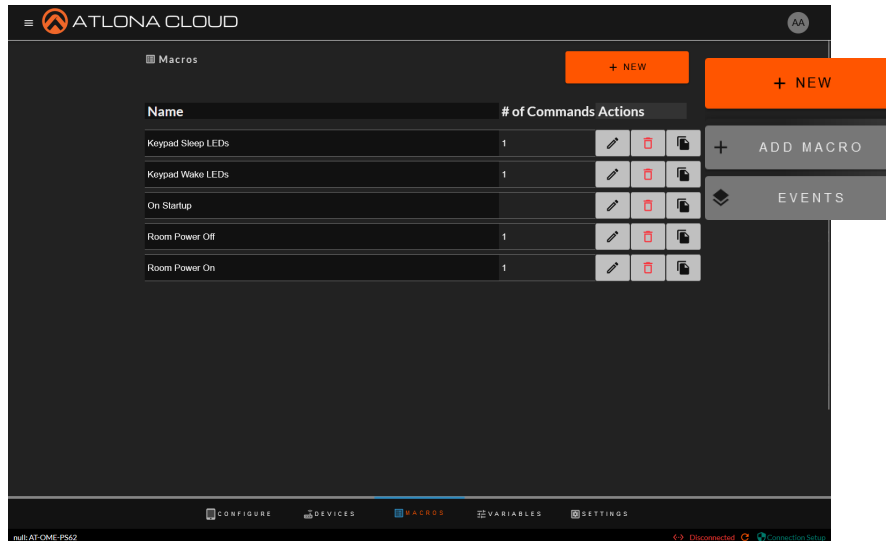

Macros can be set up before configuration for quick selection and events can be set up to trigger specific macros when specific variables are met.

Select Macros from the drop down. A new pop up will appear. Select the + button in the bottom left hand corner to create the first macro. Each device will have it's own set of premade commands, see the product manuals for what those commands do. VKP will have its own set of commands, they are listed below with a small explanation of what they do.

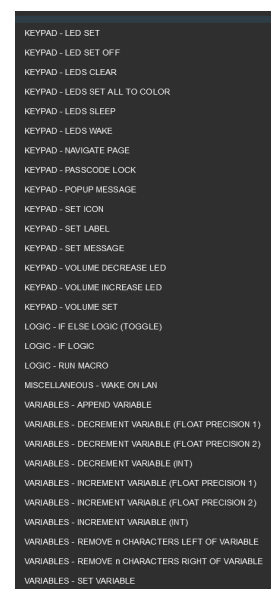
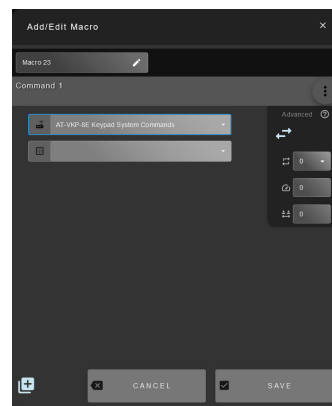
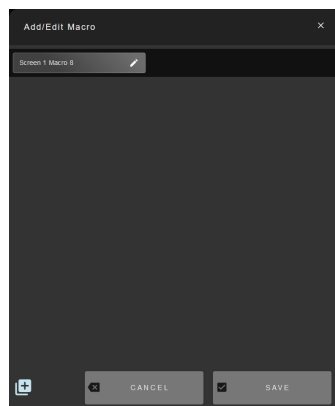

VKP-8E Macro Commands

- Keypad - LEDs set: Set the LED color of a specific button for a specific page.
- Keypad - LEDs set off: Turn an LED off for a specific button on a specific page.
- Keypad - LEDs clear: Clears all the colors from LEDs when used.
- Keypad - LEDs set all to color: Set every LED to the specified color.
- Keypad - LEDs sleep: Set the LEDs to turn off when triggered.
- Keypad - LEDs wake: Set the LEDs to turn on when triggered.
- Keypad - Navigate page: Will switch to a different control page on the VKP-8E panel when triggered.
- Keypad - Passcode lock: Locks the front panel until the correct passcode is entered.

Keypad - Popup message: When triggered, will have the specified message pop up on the panel screen.

Keypad - Set icon: Changes the icon of a specific button to the specified one.

Keypad - Set label: Changes the label for a specific button to the selected one.

Keypad - Set message: Set the message to appear on screen.

Keypad - Volume decrease LED: Will alter the color based on audio decreasing.

Keypad - Volume increase LED: Will alter the color based on audio increasing.

Keypad - Volume set: Sets the LED volume to a specific level.

Logic - IF Else logic: This can set multiple commands to a single variable based on values.

Logic - IF logic: This will provide a way to run a second command based off a variable being a certain value.

Logic - Run macro: Will run previously created macros when activated.

Miscellaneous - Wake on LAN: Will trigger the device at the specified MAC address using the Wake On LAN "magic packets".

Variables - Append Variable: This will adjust a variable with the append's set value.

Variables - Decrement Variable (Float Precision 1): This will decrease a variable by the set 1/10th value (e.g. 0.5).

Variables - Decrement Variable (Float Precision 2): This will decrease a variable by the set 1/100th value (e.g. 0.05).

Variables - Decrement Variable (INT): This will decrease a variable by the set whole number amount.

Variables - Increment Variable (Float Precision 1): This will increase a variable by the set 1/10th value (e.g. 0.5).

Variables - Increment Variable (Float Precision 2): This will increase a variable by the set 1/100th value (e.g. 0.05).

Variables - Increment Variable (INT): This will increase a variable by the set whole number amount.

Variables - Remove n Characters left of Variable: This will remove a set amount of characters from the left side of a variable value.

Variables - Remove n Characters right of Variable: This will remove a set amount of characters from the right side of a variable value..

Variables - Set Variable: Use to change a variable value.

Select Events from the drop down. A new pop up will appear. Select the + button in the bottom left hand corner to create the first event. When specific variables are met, the selected Macro will trigger.

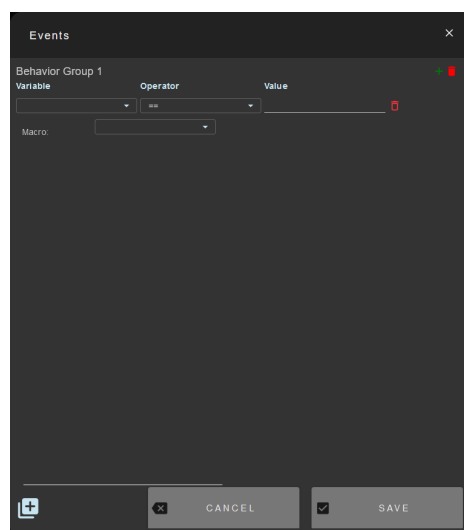
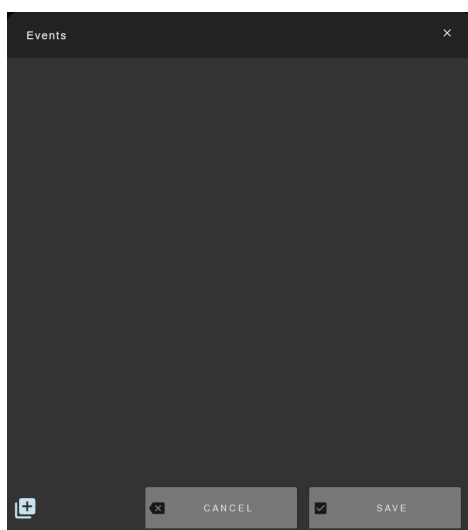

Configure

Control configuration of up to 10 device can be set up in pages and those pages can be navigated through and altered to meet needs. Create new pages for each device and set each control for what's needed. All devices have preset commands and variables based off the individual APIs. To view those commands and variables, open the API documents.

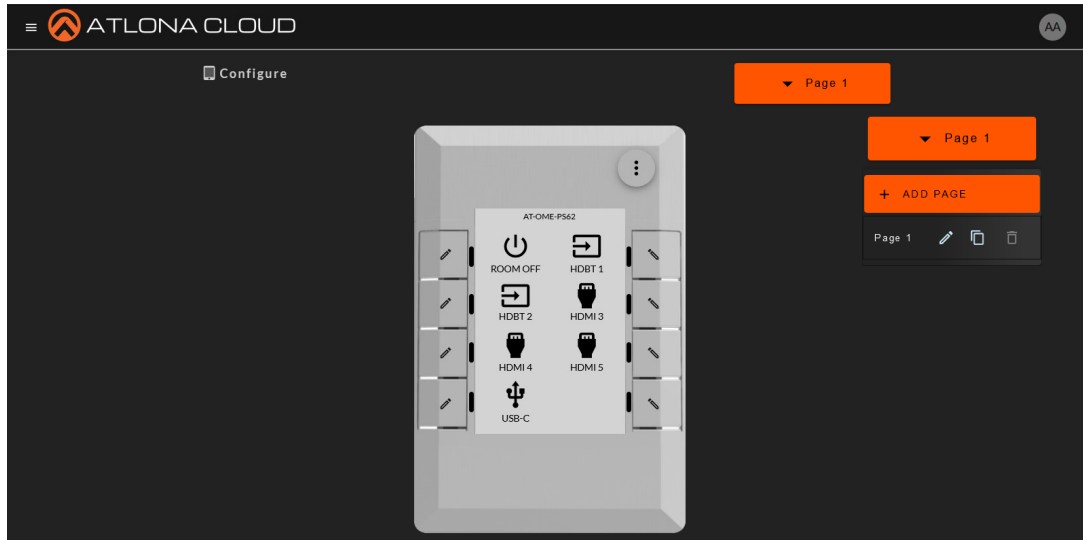

Select the Page 1 drop down to edit the page name or add a new page. Select +Add Page to create all the needed pages for configuration. Once the pages are created, their settings can be adjusted and titles set. Select the : in the top right corner of the VKP-8E image to expand the menu. There will be 4 options: Live Mode, More, Room On, and Room Off.



- More: A new page menu will open to allow for device configuration. A pop up will appear with page configuration.

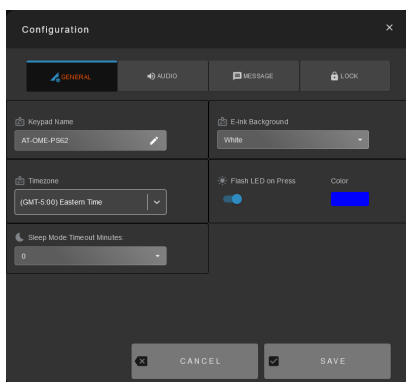

General

- Keypad Name: This will change the name displayed at the top of the current page.
- E-Ink Background: Set color of the background and text. White background will have black text and black background will have white text.
- Timezone: Set the timezone to match where the unit is located.
- Flash LED on Press: Set the color that LEDs will flash when buttons are pressed
- Sleep Mode Timeout Minutes: Set the time in minutes of inactivity before the unit will go to sleep.

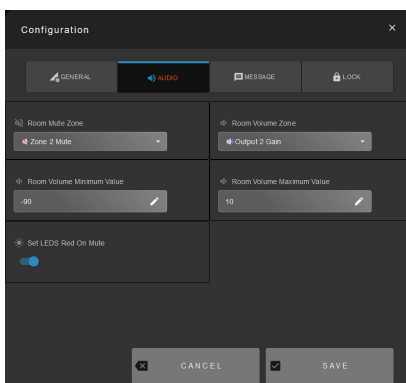

Audio

- Room Mute Zone: Select the device zone that will mute when the audio mute is triggered.
- Room Volume Zone: Select the audio port that will be adjusted when Room Volume is used.
- Room Volume Minimum / Maximum Value: Set the values for the minimum and maximum of the room device.
- Set LEDs Red on Mute: When enabled and the room audio is muted, the LED will be set to red.

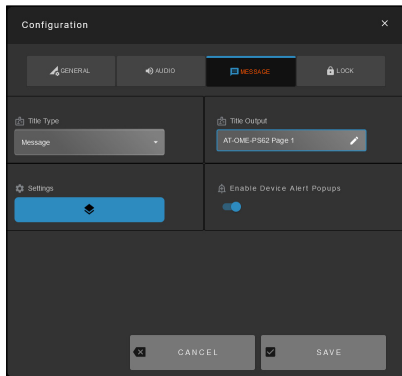

Message

- Title Type: Select whether the top text will be a clock or a message.
- Title Output: Only editable when Message is selected. Set the title that will display at the top of the elnk display on the current page.
- Settings:
 - o Message - Set up variables to alter the title of the room when the conditions are met.
 - o Clock - When selected, the format of the clock can be set.
- Enable Device Alert Popups: Allow alerts to show when enabled.

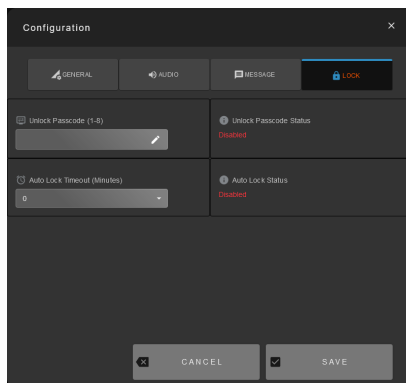

Lock

- Unlock Passcode: Set a 4-digit passcode to unlock the panel for use.
- Unlock Passcode Status: If no passcode is set, it will show disabled. If a 4-digit passcode is set, it will show status as Enabled.
- Auto Lock Timeout (Minutes): Sets the amount of time for inactivity before the unit automatically locks the front screen.
- Auto Lock Status: If a timeout amount is set, it will show enabled. If no timeout amount is set, it will show disabled.



- Room On: Set up all device macros to be triggered on this button press.
- Room Off: Set up all device macros to be triggered on this button press.

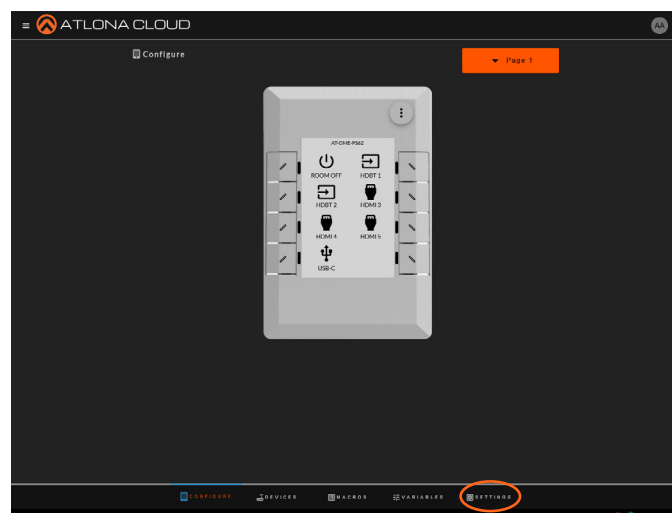

Now that configuration is complete, it must be applied to the unit. Press the Apply button in the top right corner, this will push the configuration to the connected VKP. If the VKP has internet disabled, select Settings in the bottom navigation to open the settings page. Once within settings, select export to download to the local PC for manual upload to the unit. A snapshot can also be saved at this time.

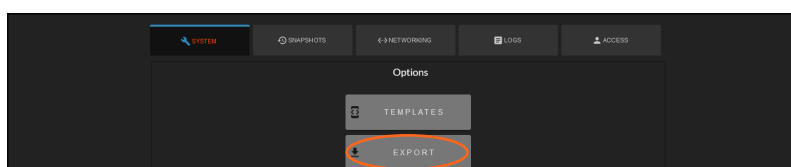

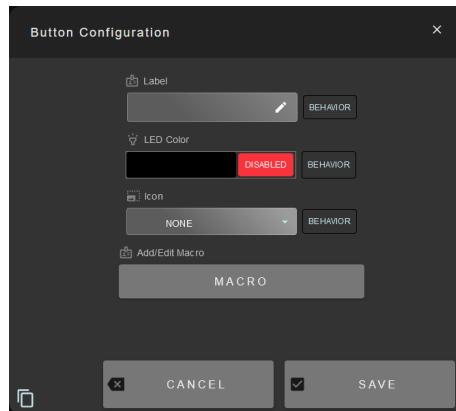

Enter a name into the label for what will display on the elnk display for the button, then select behavior to have the label change when variables are met.

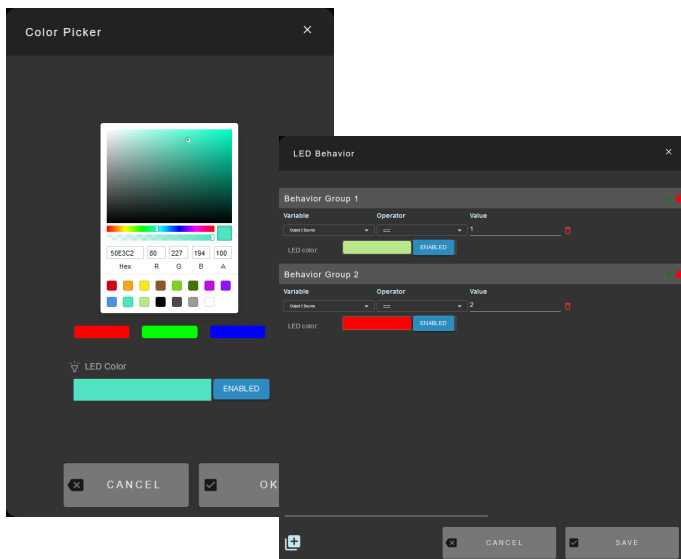
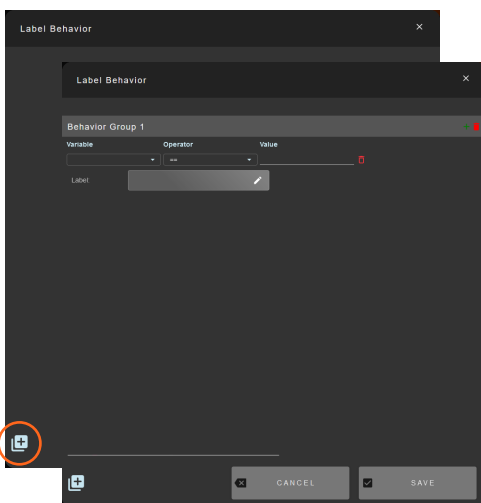

Select the color or the enable/disable button to add a color to the LED next to the selected button. Variables can be set to change the LED color whenever certain conditions are met. When disabled, the LED of that button will remain off.

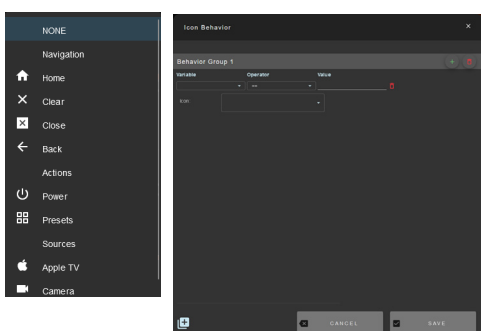

Select the icon that will display on the elnk display for the selected button. Choose the behavior button to add variables that when met will change the icon.

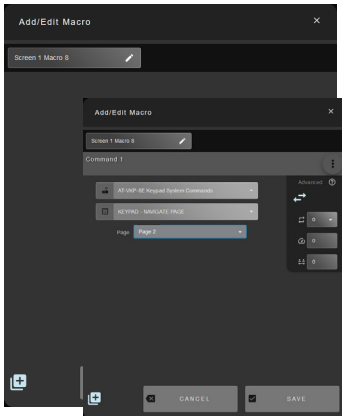

Select macros to be triggered on button press. Once set up, select the save button. Repeat for all buttons on all the pages that will be used.

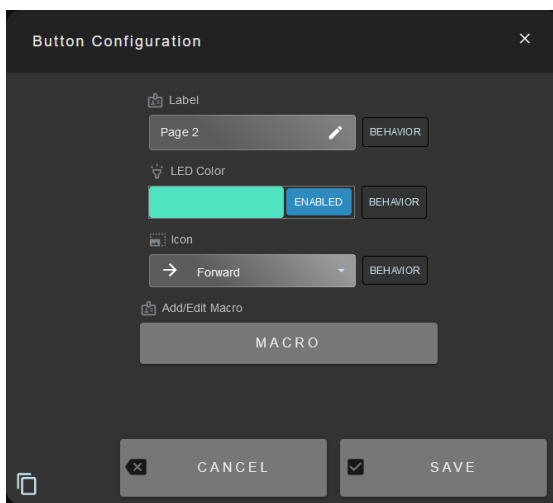

Example for button creation: Next Page button

- Set the label name. In this example the button was named Page 2. Behaviors can be added if needed.
- *Optional* Set an LED color. In this case, blue was selected. Behaviors can be added if needed.
- Select the icon for the button. In this case, since the button will be changing the unit from page 1 to page 2, the forward button was selected.
- Select the Macro button. In the new window, select the add button in the bottom left corner to create the command to be triggered by the button press.
- To change the page, select AT-VKP-8E Keypad System Commands from the first drop down.
- In the second drop down, select the system command: Keypad - Navigate Page. A new option will appear below.
- Select page 2 from the page options (all pages created will appear in this menu).
- Press the Save button. The button is now set up and ready to use.

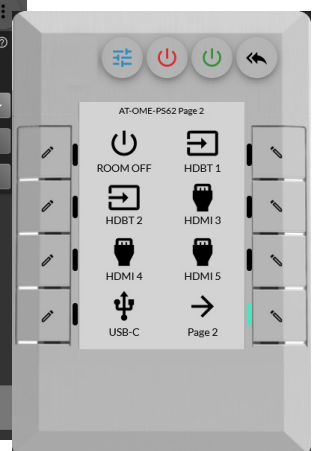
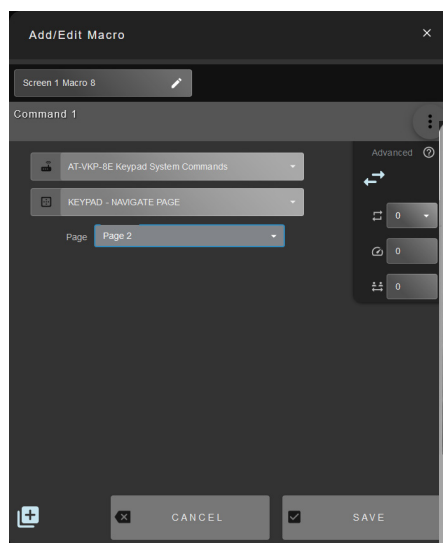
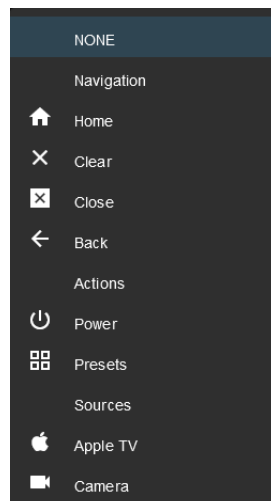
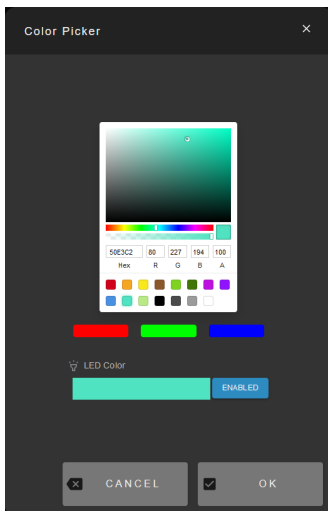

Every button can be configured to do specific commands and display different colored LEDs. Select the edit pencil on each button to configure. A pop up will appear

Appendix

Specifications

System	
CPU	i.MX6 with Cortex A7 @900 MHz
OS	Linux
RAM	LVDDR3 512Mb
Flash Memory	EMMC 4GB

Display	
Panel	2.7inch e-ink
Resolution	264x172 pixel
Color	white/black

IP	
Port	1 x RJ45
Standards and Protocols	DHCP, HTTP, HTTPS, TCP, NTP, IPv4, IPv6
Ethernet Speed	10/100 Mbps
Addressing	DHCP, static

Temperature	Fahrenheit	Celsius
Operating	32 to 122	0 to 50
Storage	-25 to 158	-32 to 70
Humidity (RH)	10% to 90%, non-condensing	

Power	
PoE	IEE 802.3at/af

Dimensions	Inches	Millimeters
H x W x D (bezel)	4.49 x 2.75 x 0.45	114 x 69.8 x 11.4
H x W x D (w/back box)	4.49 x 2.75 x 1.72	114 x 69.8 x 43.8
Wall size	1-gang	

Weight	Pounds	Kilograms
Device	0.33	0.15

Certification	
Device	CE, FCC, RCM, China RoHS, UKCA, ICES

